



Recommendation ITU-R M.1371-4
(04/2010)

**Technical characteristics for an automatic
identification system using time-division
multiple access in the VHF maritime
mobile band**

M Series
**Mobile, radiodetermination, amateur
and related satellite services**

Foreword

The role of the Radiocommunication Sector is to ensure the rational, equitable, efficient and economical use of the radio-frequency spectrum by all radiocommunication services, including satellite services, and carry out studies without limit of frequency range on the basis of which Recommendations are adopted.

The regulatory and policy functions of the Radiocommunication Sector are performed by World and Regional Radiocommunication Conferences and Radiocommunication Assemblies supported by Study Groups.

Policy on Intellectual Property Right (IPR)

ITU-R policy on IPR is described in the Common Patent Policy for ITU-T/ITU-R/ISO/IEC referenced in Annex 1 of Resolution ITU-R 1. Forms to be used for the submission of patent statements and licensing declarations by patent holders are available from <http://www.itu.int/ITU-R/go/patents/en> where the Guidelines for Implementation of the Common Patent Policy for ITU-T/ITU-R/ISO/IEC and the ITU-R patent information database can also be found.

Series of ITU-R Recommendations

(Also available online at <http://www.itu.int/publ/R-REC/en>)

Series	Title
BO	Satellite delivery
BR	Recording for production, archival and play-out; film for television
BS	Broadcasting service (sound)
BT	Broadcasting service (television)
F	Fixed service
M	Mobile, radiodetermination, amateur and related satellite services
P	Radiowave propagation
RA	Radio astronomy
RS	Remote sensing systems
S	Fixed-satellite service
SA	Space applications and meteorology
SF	Frequency sharing and coordination between fixed-satellite and fixed service systems
SM	Spectrum management
SNG	Satellite news gathering
TF	Time signals and frequency standards emissions
V	Vocabulary and related subjects

Note: This ITU-R Recommendation was approved in English under the procedure detailed in Resolution ITU-R 1.

Electronic Publication
Geneva, 2010

© ITU 2010

All rights reserved. No part of this publication may be reproduced, by any means whatsoever, without written permission of ITU.

RECOMMENDATION ITU-R M.1371-4*

Technical characteristics for an automatic identification system using time-division multiple access in the VHF maritime mobile band

(Question ITU-R 232/5)

(1998-2001-2006-2007-2010)

Scope

This Recommendation provides the technical characteristics of an automatic identification system (AIS) using time division multiple access in the VHF maritime mobile band.

The ITU Radiocommunication Assembly,

considering

- a) that the International Maritime Organization (IMO) has a continuing requirement for a universal shipborne automatic identification system (AIS);
- b) that the use of a universal shipborne AIS allows efficient exchange of navigational data between ships and between ships and shore stations, thereby improving safety of navigation;
- c) that a system using self-organized time division multiple access (SOTDMA) accommodates all users and meets the likely future requirements for efficient use of the spectrum;
- d) that although this system is intended to be used primarily for surveillance and safety of navigation purposes in ship to ship use, ship reporting and vessel traffic services (VTS) applications, it may also be used for other maritime safety related communications, provided that the primary functions are not impaired;
- e) that this system is autonomous, automatic, continuous and operate primarily in a broadcast, but also in an assigned and in an interrogation mode using time division multiple access (TDMA) techniques;
- f) that this system is capable of expansion to accommodate future expansion in the number of users and diversification of applications, including vessels which are not subject to IMO AIS carriage requirements, aids to navigation and search and rescue;
- g) that IALA maintains and publishes technical guidelines for the manufacturers of AIS and other interested parties,

recommends

- 1** that the AIS should be designed in accordance with the operational characteristics given in Annex 1 and the technical characteristics given in Annexes 2, 3, 4, 6, 7, 8 and 9;
- 2** that applications of the AIS which make use of application specific messages of the AIS, as defined in Annex 2, should comply with the characteristics given in Annex 5;

* This Recommendation should be brought to the attention of the International Maritime Organization (IMO), the International Civil Aviation Organization (ICAO), the International Association of Marine Aids to Navigation and Lighthouse Authorities (IALA), the International Electrotechnical Commission (IEC) and the Comité International Radio Maritime (CIRM).

3 that the AIS applications should take into account the international application identifier branch, as specified in Annex 5, maintained and published by IMO;

4 that the AIS design should take into account technical guidelines maintained and published by IALA.

Annex 1

Operational characteristics of an AIS using TDMA techniques in the VHF maritime mobile band

1 General

1.1 The system should automatically broadcast ships dynamic and some other information to all other installations in a self-organized manner.

1.2 The system installation should be capable of receiving and processing specified interrogating calls.

1.3 The system should be capable of transmitting additional safety information on request.

1.4 The system installation should be able to operate continuously while under way or at anchor.

1.5 The system should use TDMA techniques in a synchronized manner.

1.6 The system should be capable of three modes of operation, autonomous, assigned and polled.

2 AIS equipment

2.1 AIS VHF data link (VDL) non-controlling stations

2.1.1 AIS shipborne station

2.1.1.1 Class A shipborne mobile equipment using SOTDMA technology as described in Annex 2 will comply with relevant IMO AIS carriage requirement:

2.1.1.2 Class B shipborne mobile equipment will provide facilities not necessarily in full accordance with IMO AIS carriage requirement.

– Class B “SO” using SOTDMA technology as described in Annex 2;

– Class B “CS” using CSTDMA as described in Annex 7.

2.1.2 Aids to navigation-AIS station

2.1.3 Limited base station (no VDL control functionality)

2.1.4 Search and rescue mobile aircraft equipment

The AIS SAR aircraft station should transmit position report Message 9, and static data using Message 5 and Messages 24A and 24B.

2.1.5 Repeater station

2.1.6 AIS search and rescue transmitter (AIS-SART station)

The AIS SART station should transmit Message 1 and Message 14 using the burst transmissions as described in Annex 9.

The Messages 1 and 14 should use a user ID 970xxyyyy (where xx = manufacturer ID 01 to 99; yyyy = the sequence number 0000 to 9999) and Navigational Status 14.

The Message 14 should have the following content:

When active: SART ACTIVE

Under test: SART TEST

2.2 AIS VDL controlling stations

2.2.1 Base station

3 Identification

For the purpose of identification, the appropriate maritime mobile service identity (MMSI) should be used, as defined in Article 19 of the Radio Regulations (RR) and Recommendation ITU-R M.585. Recommendation ITU-R M.1080 should not be applied with respect to the 10th digit (least significant digit). AIS units should only transmit if an MMSI is programmed.

4 Information content

AIS stations should provide static, dynamic and voyage related data as appropriate.

4.1 Short safety related messages

Class A shipborne mobile equipment should be capable of receiving and transmitting short safety related messages containing important navigational or important meteorological warning.

Class B shipborne mobile equipment should be capable of receiving short safety related messages.

4.2 Information update intervals for autonomous mode

4.2.1 Reporting interval

The different information types are valid for different time periods and thus need different update intervals.

Static information: Every 6 min or, when data has been amended, on request.

Dynamic information: Dependent on speed and course alteration according to Tables 1 and 2.

Voyage related information: Every 6 min or, when data has been amended, on request.

Safety related message: As required.

TABLE 1

Class A shipborne mobile equipment reporting intervals

Ship's dynamic conditions	Nominal reporting interval
Ship at anchor or moored and not moving faster than 3 knots	3 min ⁽¹⁾
Ship at anchor or moored and moving faster than 3 knots	10 s ⁽¹⁾
Ship 0-14 knots	10 s ⁽¹⁾
Ship 0-14 knots and changing course	3 1/3 s ⁽¹⁾
Ship 14-23 knots	6 s ⁽¹⁾
Ship 14-23 knots and changing course	2 s
Ship >23 knots	2 s
Ship >23 knots and changing course	2 s

⁽¹⁾ When a mobile station determines that it is the semaphore (see § 3.1.1.4, Annex 2), the reporting interval should decrease to 2 s (see § 3.1.3.3.2, Annex 2).

NOTE 1 – These values have been chosen to minimize unnecessary loading of the radio channels while maintaining compliance within the IMO AIS performance standards.

NOTE 2 – If the autonomous mode requires a shorter reporting interval than the assigned mode, the Class A shipborne mobile AIS station should use the autonomous mode.

TABLE 2

Reporting intervals for equipment other than Class A shipborne mobile equipment

Platform's condition	Nominal reporting interval
Class B "SO" shipborne mobile equipment not moving faster than 2 knots	3 min ⁽¹⁾
Class B "SO" shipborne mobile equipment moving 2-14 knots	30 s ⁽¹⁾
Class B "SO" shipborne mobile equipment moving 14-23 knots	15 s ^{(1), (3)}
Class B "SO" shipborne mobile equipment moving > 23 knots	5 s ^{(1), (3)}
Class B "CS" shipborne mobile equipment not moving faster than 2 knots	3 min
Class B "CS" shipborne mobile equipment moving faster than 2 knots	30 s
Search and rescue aircraft (airborne mobile equipment) ⁽⁴⁾	10 s
Aids to navigation	3 min
AIS base station ⁽²⁾	10 s

⁽¹⁾ When a mobile station determines that it is the semaphore (see § 3.1.1.4, Annex 2) the reporting interval (RI) should decrease to 2 s (see § 3.1.3.3.2, Annex 2).

⁽²⁾ The base station's RI should decrease to 3 1/3 s after the station detects that one or more stations are synchronizing to the base station (see § 3.1.3.3.1, Annex 2).

⁽³⁾ The nominal RI for Class B "CS" is 30 s.

⁽⁴⁾ Shorter RI down to 2 s could be used in the area of search and rescue operations.

5 Frequency band

AIS stations should be designed for operation in the VHF maritime mobile band, with 25 kHz bandwidth, in accordance with RR Appendix 18 and Recommendation ITU-R M.1084, Annex 4.

The minimum requirement for certain types of equipment may be a subset of the VHF maritime band.

Two international channels have been allocated in RR Appendix 18 for AIS use.

The system should be able to operate on two parallel VHF channels. When the designated AIS channels are not available the system should be able to select alternative channels using channel management methods in accordance with this Recommendation.

Annex 2

Technical characteristics of an AIS using TDMA techniques in the maritime mobile band

1 Structure of the AIS

This Annex describes the characteristics of SOTDMA, random access TDMA (RATDMA), incremental TDMA (ITDMA) and fixed access TDMA (FATDMA) techniques (see Annex 7 for carrier-sense TDMA (CSTDMA) technique).

1.1 AIS layer module

This Recommendation covers layers 1 to 4 (physical layer, link layer, network layer, transport layer) of the open system interconnection (OSI) model.

Figure 1 illustrates the layer model of an AIS station (physical layer to transport layer) and the layers of the applications (session layer to application layer):

FIGURE 1

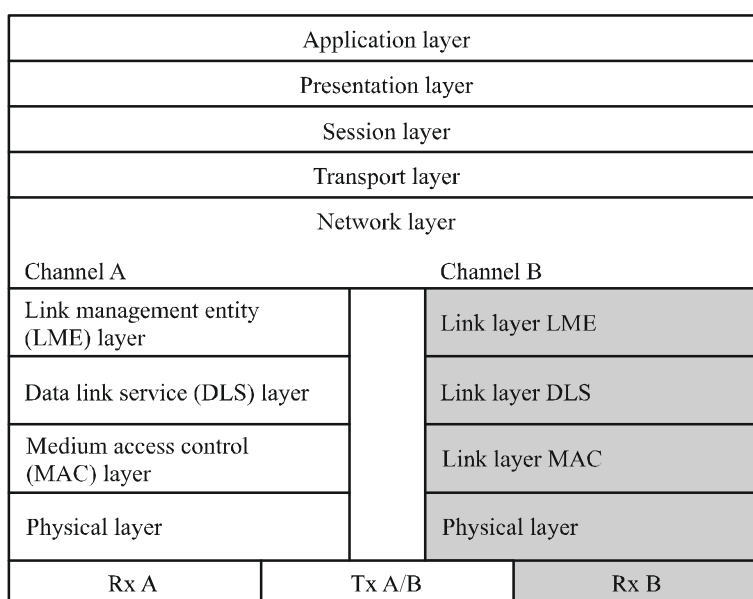

Rx: receiver
Tx: transmitter

1.2 Responsibilities of AIS layers for preparing AIS data for transmission

1.2.1 Transport layer

The transport layer is responsible for converting data into transmission packets of correct size and sequencing of data packets.

1.2.2 Network layer

The network layer is responsible for the management of priority assignments of messages, distribution of transmission packets between channels, and data link congestion resolution.

1.2.3 Link layer

The link layer is divided into three sub-layers with the following tasks:

1.2.3.1 Link management entity

Assemble AIS message bits, see Annex 8.

Order AIS message bits into 8-bit bytes for assembly of transmission packet, see § 3.3.7.

1.2.3.2 Data link services

Calculate frame check sequence (FCS) for AIS message bits, see § 3.2.2.6.

Append FCS to AIS message to complete creation of transmission packet contents see § 3.2.2.2.

Apply bit stuffing process to transmission packet contents, see § 3.2.2.1.

Complete assembly of transmission packet, see § 3.2.2.2.

1.2.3.3 Media access control

Provides a method for granting access to the data transfer to the VDL. The method used is a TDMA scheme using a common time reference.

1.2.4 Physical layer

Non return zero inverted (NRZI) encode assembled transmission packet see § 2.3.1.1 or § 2.6.

Convert digital NRZI coded transmission packet to analogue Gaussian-filtered minimum shift keying (GMSK) signal to modulate transmitter, see § 2.3.1.1.

2 Physical layer

2.1 Parameters

2.1.1 General

The physical layer is responsible for the transfer of a bit-stream from an originator, out on to the data link. The performance requirements for the physical layer are summarized in Tables 3 to 5.

For transmit output power see also § 2.12.2.

The low setting and the high setting for each parameter is independent of the other parameters.

TABLE 3

Symbol	Parameter name	Low setting	High setting
PH.RFR	Regional frequencies (range of frequencies within RR Appendix 18) ⁽¹⁾ (MHz)	156.025	162.025
PH.CHS	Channel spacing (encoded according to RR Appendix 18 with footnotes) ⁽¹⁾ (kHz)	25	25
PH.AIS1	AIS 1 (default channel 1) (2087) ⁽¹⁾ (see § 2.3.3) (MHz)	161.975	161.975
PH.AIS2	AIS 2 (default channel 2) (2088) ⁽¹⁾ (see § 2.3.3) (MHz)	162.025	162.025
PH.BR	Bit rate (bit/s)	9 600	9 600
PH.TS	Training sequence (bits)	24	24
PH.TXBT	Transmit BT product	~0.4	~0.4
PH.RXBT	Receive BT product	~0.5	~0.5
PH.MI	Modulation index	~0.5	~0.5
PH.TXP	Transmit output power (W)	1	12.5

⁽¹⁾ See Recommendation ITU-R M.1084, Annex 4.

2.1.2 Constants

TABLE 4

Symbol	Parameter name	Value
PH.DE	Data encoding	NRZI
PH.FEC	Forward error correction	Not used
PH.IL	Interleaving	Not used
PH.BS	Bit scrambling	Not used
PH.MOD	Modulation	GMSK/FM

GMSK/FM: see § 2.3.

2.1.3 Transmission media

Data transmissions are made in the VHF maritime mobile band. Data transmissions should default to AIS 1 and AIS 2 unless specified by a channel management command, Message 20 or DSC telecommand, as described in § 3.18 Annex 8 and § 3.1 Annex 3.

2.1.4 Dual channel operation

The transponder should be capable of operating on two parallel channels in accordance with § 4.1. Two separate TDMA receivers should be used to simultaneously receive on two independent frequency channels. One TDMA transmitter should be used to alternate TDMA transmissions on two independent frequency channels.

2.2 Transceiver characteristics

The transceiver should perform in accordance with the characteristics set forth herein.

TABLE 5

Minimum required TDMA transmitter characteristics

Transmitter parameters	Required results
Carrier power error	± 1.5 dB
Carrier frequency error	± 500 Hz
Slotted modulation mask	-25 dBc $\Delta f_c < \pm 10$ kHz -70 dBc ± 25 kHz $< \Delta f_c < \pm 62.5$ kHz
Transmitter test sequence and modulation accuracy	< 3 400 Hz for bit 0, 1 $2\ 400 \pm 480$ Hz for bit 2, 3 $2\ 400 \pm 240$ Hz for bit 4 ... 31 For bits bit 32 ... 199 $1\ 740 \pm 175$ Hz for a bit pattern of 0101 $2\ 400 \pm 240$ Hz for a bit pattern of 00001111
Transmitter output power versus time	Power within mask shown in Fig. 2 and timings given in Table 6
Spurious emissions	-36 dBm 9 kHz ... 1 GHz -30 dBm 1 GHz ... 4 GHz
Intermodulation attenuation (base station only)	≥ 40 dB

TABLE 6

Definitions of timing for Fig. 2

Reference	Bits	Time (ms)	Definition
T_0	0	0	Start of transmission slot. Power should NOT exceed -50 dB of P_{SS} before T_0
T_A	0-6	0-0.625	Power exceeds -50 dB of P_{SS}
T_B	T_{B1}	6	Power should be within $+1.5$ or -3 dB of P_{SS} (<i>start of training sequence</i>)
	T_{B2}	8	Power should be within $+1.5$ or -1 dB of P_{SS}
T_E (includes 1 stuffing bit)	233	24.271	Power should remain within $+1.5$ or -1 dB of P_{SS} during the period T_{B2} to T_E
T_F (includes 1 stuffing bit)	241	25.104	Power should be -50 dB of P_{SS} and stay below this
T_G	256	26.667	Start of next transmission time period

TABLE 7

Minimum required TDMA receiver characteristics

Receiver parameters	Required results
Sensitivity	20% PER @ -107 dBm
Error behaviour at high input levels	1% PER @ -77 dBm 1% PER @ -7 dBm
Adjacent channel selectivity	20% PER @ 70 dB
Co-channel selectivity	20% PER @ 10 dB
Spurious response rejection	20% PER @ 70 dB
Intermodulation response rejection	20% PER @ 74 dB
Spurious emissions	-57 dBm (9 kHz to 1 GHz) -47 dBm (1 GHz to 4 GHz)
Blocking	20% PER @ 86 dB

2.3 Modulation scheme

The modulation scheme is frequency modulated Gaussian filtered minimum shift keying (GMSK/FM).

2.3.1 GMSK

2.3.1.1 The NRZI encoded data should be GMSK coded before frequency modulating the transmitter.

2.3.1.2 The GMSK modulator BT-product used for transmission of data should be 0.4 maximum (highest nominal value).

2.3.1.3 The GMSK demodulator used for receiving of data should be designed for a BT-product of maximum 0.5 (highest nominal value).

2.3.2 Frequency modulation

The GMSK coded data should frequency modulate the VHF transmitter. The modulation index should be 0.5.

2.3.3 Frequency stability

The frequency stability of the VHF radio transmitter/receiver should be ± 500 Hz or better.

2.4 Data transmission bit rate

The transmission bit rate should be 9 600 bit/s ± 50 ppm.

2.5 Training sequence

Data transmission should begin with a 24-bit demodulator training sequence (preamble) consisting of one segment synchronization. This segment should consist of alternating zeros and ones (0101....). This sequence may begin with a 1 or a 0 since NRZI encoding is used.

2.6 Data encoding

The NRZI waveform is used for data encoding. The waveform is specified as giving a change in the level when a zero (0) is encountered in the bit stream.

2.7 Forward error correction

Forward error correction is not used.

2.8 Interleaving

Interleaving is not used.

2.9 Bit scrambling

Bit scrambling is not used.

2.10 Data link sensing

Data link occupancy and data detection are entirely controlled by the link layer.

2.11 Transmitter transient response

The attack, settling and decay characteristics of the RF transmitter should comply with the mask shown in Fig. 2 and defined in Table 6.

FIGURE 2
Transmitter output envelope versus time

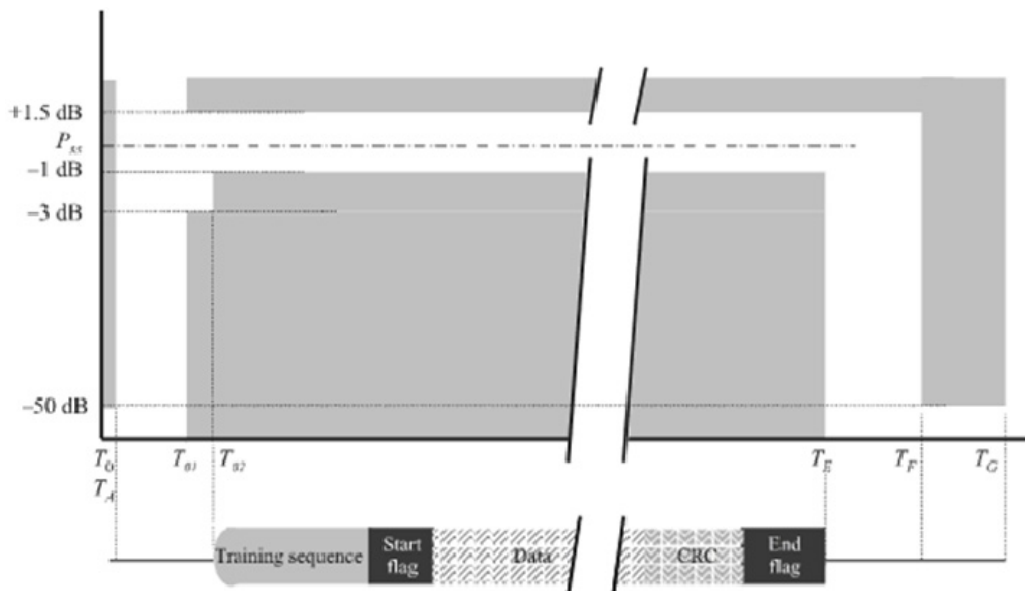

1371-02

2.11.1 Switching time

The channel switching time should be less than 25 ms (see Fig. 8).

The time taken to switch from transmit to receive conditions, and vice versa, should not exceed the transmit attack or release time. It should be possible to receive a message from the slot directly after or before own transmission.

The equipment should not be able to transmit during channel switching operation.

The equipment is not required to transmit on the other AIS channel in the adjacent time slot.

2.12 Transmitter power

The power level is determined by the LME of the link layer.

2.12.1 Provision should be made for two levels of nominal power (high power, low power) as required by some applications. The default operation of the transponder should be on the high nominal power level. Changes to the power level should only be by assignment by the approved channel management means (see § 4.1.1).

2.12.2 The nominal levels for the two power settings should be 1 W and 12.5 W. Tolerance should be within ±1.5 dB.

2.13 Shutdown procedure

2.13.1 An automatic transmitter hardware shutdown procedure and indication should be provided in case a transmitter continues to transmit for more than 2 s. This shutdown procedure should be independent of software control.

2.14 Safety precautions

The AIS installation, when operating, should not be damaged by the effects of open circuited or short circuited antenna terminals.

3 Link layer

The link layer specifies how data is packaged in order to apply error detection and correction to the data transfer. The link layer is divided into three (3) sub-layers.

3.1 Sub-layer 1: medium access control

The medium access control (MAC) sub layer provides a method for granting access to the data transfer medium, i.e. the VHF data link. The method used is a TDMA scheme using a common time reference.

3.1.1 TDMA synchronization

TDMA synchronization is achieved using an algorithm based on a synchronization state as described below. The sync state flag within SOTDMA communication state (see § 3.3.7.2.1) and within incremental TDMA (ITDMA) communication state (see § 3.3.7.3.2), indicates the synchronization state of a station (see Figs 3 and 4).

The TDMA receiving process should not be synchronized to slot boundaries.

Parameters for TDMA synchronization:

TABLE 8

Symbol	Parameter name/description	Nominal
MAC.SyncBaseRate	Sync support increased update rate (base station)	Once per 3 1/3 s
MAC.SyncMobileRate	Sync support increased update rate (mobile station)	Once per 2 s

3.1.1.1 UTC direct

A station, which has direct access to UTC timing with the required accuracy should indicate this by setting its synchronization state to UTC direct.

3.1.1.2 UTC indirect

A station, which is unable to get direct access to UTC, but can receive other stations that indicate UTC direct, should synchronize to those stations. It should then change its synchronization state to UTC indirect. Only one level of UTC indirect synchronization is allowed.

3.1.1.3 Synchronized to base station (direct or indirect)

Mobile stations, which are unable to attain direct or indirect UTC synchronization, but are able to receive transmissions from base stations, should synchronize to the base station which indicates the highest number of received stations, provided that two reports have been received from that station in the last 40 s. Once base station synchronization has been established, this synchronization shall be discontinued if fewer than two reports are received from the selected base station in the last 40 s. When the parameter slot time-out of the SOTDMA communication state has one of the values three (3), five (5), or seven (7), the number of received stations should be contained within the SOTDMA communication state-submessage. The station which is thus synchronized to a base station should then change its synchronization state to "base station" to reflect this. A station that has Sync. state = 3 (see § 3.1.3.4.3) shall synchronize to a station that has Sync. state = 2 (see § 3.1.3.4.3) if no base station or station with UTC direct is available. Only one level of indirect access to the base station is allowed.

When a station is receiving several other base stations which indicate the same number of received stations, synchronization should be based on the station with the lowest MMSI.

3.1.1.4 Number of received stations

A station, which is unable to attain UTC direct or UTC indirect synchronization and is also unable to receive transmissions from a base station, should synchronize to the station indicating the highest number of other stations received during the last nine frames, provided that two reports have been received from that station in the last 40 s. This station should then change its synchronization state to "Number of received stations" (see § 3.3.7.2.2 for SOTDMA communication state and § 3.3.7.3.2 for ITDMA communication state). When a station is receiving several other stations, which indicate the same number of received stations, synchronization should be based on the station with the lowest MMSI. That station becomes the *semaphore* on which synchronization should be performed.

3.1.2 Time division

The system uses the concept of a frame. A frame equals one (1) min and is divided into 2250 slots. Access to the data link is, by default, given at the start of a slot. The frame start and stop coincide with the UTC minute, when UTC is available. When UTC is unavailable the procedure, described below should apply.

3.1.3 Slot phase and frame synchronization

3.1.3.1 Slot phase synchronization

Slot phase synchronization is the method whereby one station uses the messages from other stations or base stations to re-synchronize itself, thereby maintaining a high level of synchronization stability, and ensuring no message boundary overlapping or corruption of messages.

Decision to slot phase synchronize should be made after receipt of end flag and valid FCS. (State T3, Fig. 8) At T5, the station resets its *Slot_Phase_Synchronization_Timer*, based on Ts, T3 and T5 (Fig. 8).

3.1.3.2 Frame synchronization

Frame synchronization is the method whereby one station uses the current slot number of another station or base station, adopting the received slot number as its own current slot number. When the parameter slot time-out of the SOTDMA communication state has one of the values two (2), four (4), or six (6), the current slot number of a received station should be contained within the sub message of the SOTDMA communication state.

3.1.3.3 Synchronization – Transmitting stations (see Fig. 3)

FIGURE 3

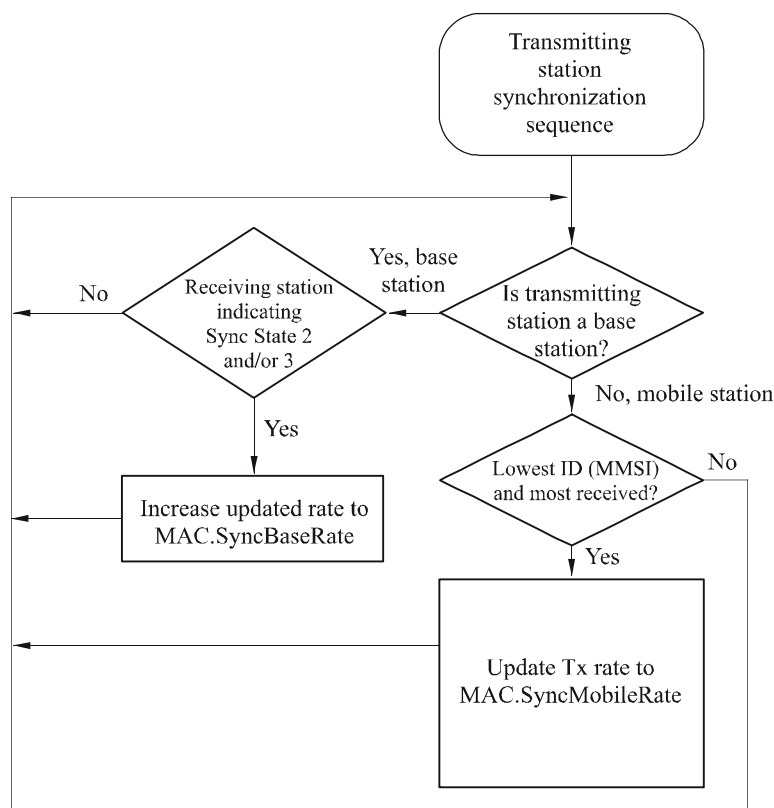

1371-03

3.1.3.3.1 Base station operation

The base station should normally transmit the base station report (Message 4) with a minimum reporting interval of 10 s.

The base station should decrease its reporting interval of Message 4 to MAC.SyncBaseRate when it fulfils the semaphore qualifying conditions according to the table in § 3.1.3.4.3. It should remain in this state until the semaphore qualifying conditions have been invalid for the last 3 min.

3.1.3.3.2 Mobile station operation as a semaphore

When a mobile station determines that it is the semaphore (see § 3.1.1.4 and § 3.1.3.4.3), it should decrease its reporting interval to MAC.SyncMobileRate. It should remain in this state until the semaphore qualifying conditions have been invalid for the last 3 min.

3.1.3.4 Synchronization – Receiving stations (see Fig. 4)

FIGURE 4

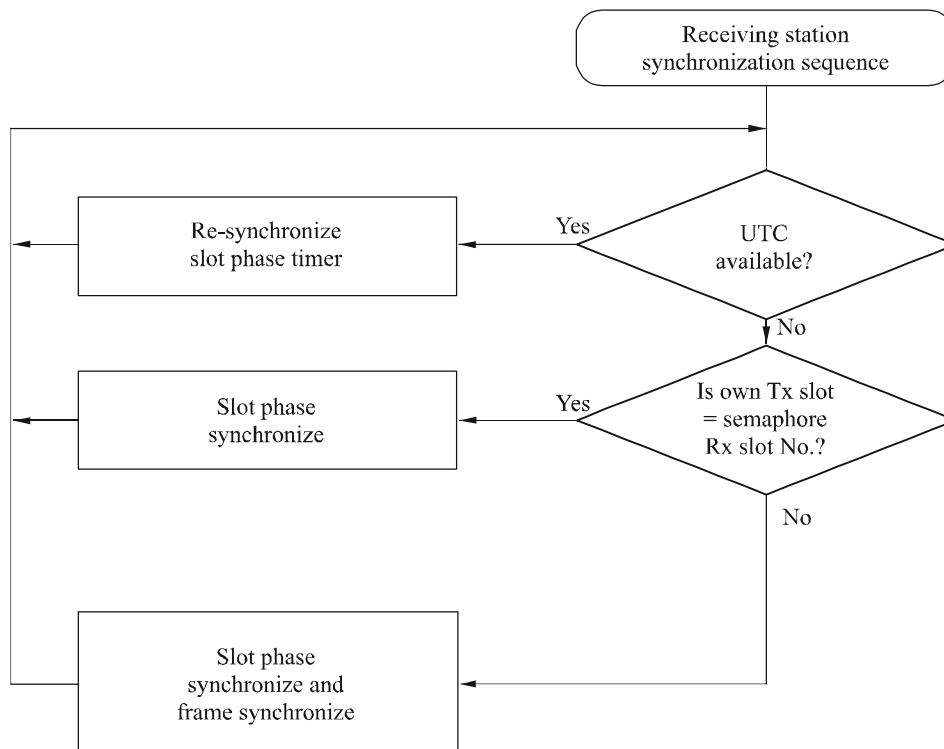

1371-04

3.1.3.4.1 UTC available

A station, which has direct access to UTC, should continuously re-synchronize its transmissions based on UTC source. A station, which has indirect access to UTC should continuously resynchronize its transmissions based on those UTC sources (see § 3.1.1.2).

3.1.3.4.2 UTC not available

When the station determines that its own internal slot number is equal to the semaphore slot number, it is already in frame synchronization and it should continuously slot phase synchronize.

3.1.3.4.3 Synchronization sources

The primary source for synchronization should be the integral UTC source (UTC direct). If this source should be unavailable the following external synchronization sources, listed below in the order of priority, should serve as the basis for slot phase and frame synchronizations:

- a station which has UTC time;
- a base station which is semaphore qualified;
- other station(s) which are synchronized to a base station;
- a mobile station, which is semaphore qualified.

Table 9 illustrates the different sync mode priorities and the contents of the sync state fields in the communication state.

TABLE 9
Synchronization mode

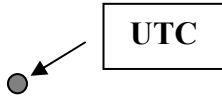
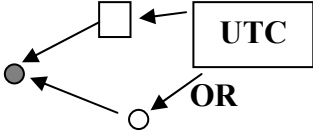
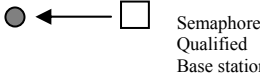
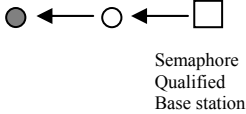
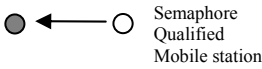
Sync mode of own station	Priority	Illustration	Sync state (in communication state) of own station	May be used as source for indirect sync by other station(s)
UTC direct	1		0	Yes
UTC indirect	2		1	No
Base direct	3		2	Yes
Base indirect	4		3	No
Mobile as semaphore	5		3	No

A mobile station should only be semaphore qualified under following condition:

TABLE 10

		Highest received synchronization state value			
Mobile station's synchronization state value	Own mobile station's sync state	0	1	2	3
	0	No	No	No	No
	1	No	No	No	Yes
	2	No	No	No	No
	3	No	No	No	Yes

0 = UTC direct (see § 3.1.1.1).

1 = UTC indirect (see § 3.1.1.2).

2 = Station is synchronized to a base station (see § 3.1.1.3).

3 = Station is synchronized to another station based on the highest number of received stations (see § 3.1.1.4) or indirect to a base station.

If more than one station is semaphore qualified, then the station indicating the highest number of received stations should become the active semaphore station. If more than one station indicates the same number of received stations, then the one with the lowest MMSI number becomes the active semaphore station.

A base station should only be semaphore qualified under following condition:

TABLE 11

		Highest received synchronization state value			
		0	1	2	3
Base station's synchronization state value	Own base station's sync state				
	0	No	No	No	No
	1	No	No	Yes	Yes
	2	No	No	Yes	Yes
	3	No	No	Yes	Yes

0 = UTC direct (see § 3.1.1.1).

1 = UTC indirect (see § 3.1.1.2).

2 = Station is synchronized to a base station (see § 3.1.1.3).

3 = Station is synchronized to another mobile station based on the highest number of received stations (see § 3.1.1.4) or indirect to a base station.

A base station which is semaphore qualified according to Table 11 should act as a semaphore.

See also § 3.1.1.3, § 3.1.1.4 and § 3.1.3.3 for semaphore qualification.

3.1.4 Slot identification

Each slot is identified by its index (0-2249). Slot zero (0) should be defined as the start of the frame.

3.1.5 Slot access

The transmitter should begin transmission by turning on the RF power at slot start.

The transmitter should be turned off after the last bit of the transmission packet has left the transmitting unit. This event must occur within the slots allocated for own transmission. The default length of a transmission occupies one (1) slot. The slot access is performed as shown in Fig. 5:

FIGURE 5

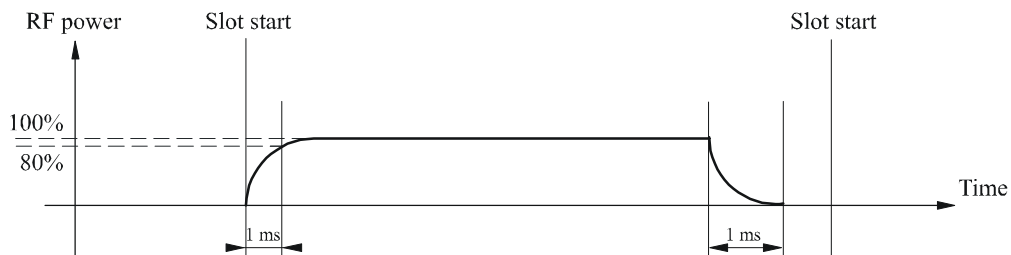

3.1.6 Slot state

Each slot can be in one of the following states:

- Free: meaning that the slot is unused within the receiving range of the own station. Externally allocated slots that have not been used during the preceding three frames are also Free slots. This slot may be considered as a candidate slot for use by own station (see § 3.3.1.2).
- Internal allocation: meaning that the slot is allocated by own station and can be used for transmission.
- External allocation: meaning that the slot is allocated for transmission by another station.
- Available: meaning that the slot is externally allocated by a station and is a possible candidate for slot reuse (see § 4.4.1).
- Unavailable: meaning that the slot is externally allocated by a station and cannot be a candidate for slot reuse (see § 4.4.1).

3.2 Sub layer 2: data link service

The data link service (DLS) sub layer provides methods for:

- data link activation and release;
- data transfer; or
- error detection and control.

3.2.1 Data link activation and release

Based on the MAC sub layer the DLS will listen, activate or release the data link. Activation and release should be in accordance with § 3.1.5. A slot, marked as free or externally allocated, indicates that own equipment should be in receive mode and listen for other data link users. This should also be the case with slots, marked as available and not to be used by own station for transmission (see § 4.4.1).

3.2.2 Data transfer

Data transfer should use a bit-oriented protocol which is based on the high-level data link control (HDLC) as specified by ISO/IEC 3309: 1993 – Definition of packet structure. Information packets (I-Packets) should be used with the exception that the control field is omitted (see Fig. 6).

3.2.2.1 Bit stuffing

The bit stream of the data portion and the FCS, see Fig. 6, § 3.2.2.5 and § 3.2.2.6, should be subject to bit stuffing. On the transmitting side, this means that if five (5) consecutive ones (1's) are found in the output bit stream, a zero should be inserted after the five (5) consecutive ones (1's). This applies to all bits between the HDLC flags (start flag and end flag, see Fig. 6). On the receiving side, the first zero after five (5) consecutive ones (1's) should be removed.

3.2.2.2 Packet format

Data is transferred using a transmission packet as shown in Fig. 6:

FIGURE 6



1371-06

The packet should be sent from left to right. This structure is identical to the general HDLC structure, except for the training sequence. The training sequence should be used in order to synchronize the VHF receiver and is discussed in § 3.2.2.3. The total length of the default packet is 256 bits. This is equivalent to one (1) slot.

3.2.2.3 Training sequence

The training sequence should be a bit pattern consisting of alternating 0's and 1's (010101010...). Twenty-four bits of preamble are transmitted prior to sending the flag. This bit pattern is modified due to the NRZI mode used by the communication circuit (see Fig. 7).

FIGURE 7

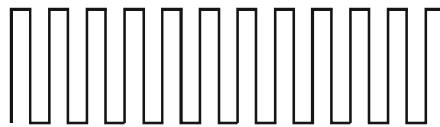

a) Unmodified bit pattern

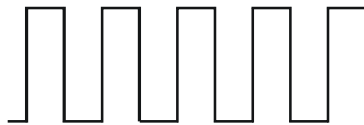

b) Modified bit pattern by NRZI

1371-07

The preamble should not be subject to bit stuffing.

3.2.2.4 Start flag

The start flag should be 8 bits long and consists of a standard HDLC flag. It is used in order to detect the start of a transmission packet. The start flag consists of a bit pattern, 8 bits long: 01111110 (7E_h). The flag should not be subject to bit stuffing, although it consists of 6 bits of consecutive ones (1's).

3.2.2.5 Data

The data portion is 168 bits long in the default transmission packet. The content of data is undefined at the DLS. Transmission of data, which occupy more than 168 bits, is described in § 3.2.2.11.

3.2.2.6 FCS

The FCS uses the cyclic redundancy check (CRC) 16-bit polynomial to calculate the checksum as defined in ISO/IEC 3309: 1993. The CRC bits should be pre-set to one (1) at the beginning of a CRC calculation. Only the data portion should be included in the CRC calculation (see Fig. 7).

3.2.2.7 End flag

The end flag is identical to the start flag as described in § 3.2.2.4.

3.2.2.8 Buffer

The buffer is normally 24 bits long and should be used as follows:

- bit stuffing: 4 bits (normally, for all messages except safety related messages and binary messages)
- distance delay: 12 bits
- repeater delay: 2 bits
- synchronization jitter: 6 bits

3.2.2.8.1 Bit stuffing

A statistical analysis of all possible bit combinations in the data field of the fixed length messages shows that 76% of combinations use 3 bits or less, for bit stuffing. Adding the logically possible bit combinations shows, that 4 bits are sufficient for these messages. Where variable length messages are used, additional bit stuffing could be required. For the case where additional bit stuffing is required, see § 5.2 and Table 21.

3.2.2.8.2 Distance delay

A buffer value of 12 bits is reserved for distance delay. This is equivalent to 202.16 nautical miles (NM). This distance delay provides protection for a propagation range of over 100 NM.

3.2.2.8.3 Repeater delay

The repeater delay provides for a turn-around time in a duplex repeater.

3.2.2.8.4 Synchronization jitter

The synchronization jitter bits preserve integrity on the TDMA data link, by allowing a jitter in each time slot, which is equivalent to ± 3 bits. Transmission timing error should be within $\pm 104 \mu\text{s}$ of the synchronization source. Since timing errors are additive, the accumulated timing error can be as much as $\pm 312 \mu\text{s}$.

3.2.2.9 Summary of the default transmission packet

The data packet is summarized as shown in Table 12:

TABLE 12

Ramp up	8 bits	T_0 to T_{TS} in Fig. 8
Training sequence	24 bits	Necessary for synchronization
Start flag	8 bits	In accordance with HDLC (7E _h)
Data	168 bits	Default
CRC	16 bits	In accordance with HDLC
End flag	8 bits	In accordance with HDLC (7E _h)
Buffer	24 bits	Bit stuffing distance delays, repeater delay and jitter
Total	256 bits	

3.2.2.10 Transmission timing

Figure 8 shows the timing events of the default transmission packet (one slot). At the situation where the ramp down of the RF power overshoots into the next slot, there should be no modulation of the RF after the termination of transmission. This prevents undesired interference, due to false locking of receiver modems, with the succeeding transmission in the next slot.

3.2.2.11 Long transmission packets

A station may occupy at maximum five consecutive slots for one (1) continuous transmission. Only a single application of the overhead (ramp up, training sequence, flags, FCS, buffer) is required for a long transmission packet. The length of a long transmission packet should not be longer than necessary to transfer the data; i.e. the AIS should not add filler.

3.2.3 Error detection and control

Error detection and control should be handled using the CRC polynomial as described in § 3.2.2.6. CRC errors should result in no further action by the AIS.

3.3 Sub layer 3 – link management entity

The link management entity (LME) controls the operation of the DLS, MAC and the physical layer.

3.3.1 Access to the data link

There should be four different access schemes for controlling access to the data transfer medium. The application and mode of operation determine the access scheme to be used. The access schemes are:

SOTDMA, ITDMA, random access TDMA (RATDMA) and fixed access TDMA (FATDMA). SOTDMA is the basic scheme used for scheduled repetitive transmissions from an autonomous station. When, for example, the reporting interval has to be changed, or a non-repetitive message is to be transmitted, other access schemes may be used.

3.3.1.1 Cooperation on the data link

The access schemes operate continuously, and in parallel, on the same physical data link. They all conform to the rules set up by the TDMA (see § 3.1).

3.3.1.2 Candidate slots

Slots, used for transmission, are selected from *candidate slots* in the selection interval (SI) (see Fig. 10). The selection process uses received data. There should always be at minimum four candidate slots to choose from unless the number of candidate slots is otherwise restricted due to loss of position information (see § 4.4.1). For Class A mobile AIS stations when selecting candidates for messages longer than one (1) slot (see § 3.2.2.11) a candidate slot should be the first slot in a consecutive block of free or available slots. For Class B “SO” mobile AIS stations the candidate slots for Messages 6, 8, 12 and 14 should be free. When no candidate slot is available, the use of the current slot is allowed. The candidate slots are primarily selected from free slots (see § 3.1.6). When required, available slots are included in the candidate slot set. When selecting a slot from the candidates, any candidate has the same probability of being chosen, regardless of its slot state (see § 3.1.6). If the station cannot find any candidate slots at all, because all slots in the SI are restricted from slot reuse (see § 4.4.1), the station should not reserve a slot in the SI until there is at least one candidate slot.

Example:

0	1	2	3	4	5	6	7
E	E	F	F	F	F	F	E

A three-slot-message is to be sent. Only slot Nos. 2, 3 and 4 should be considered candidates.

FIGURE 8
Transmission timing

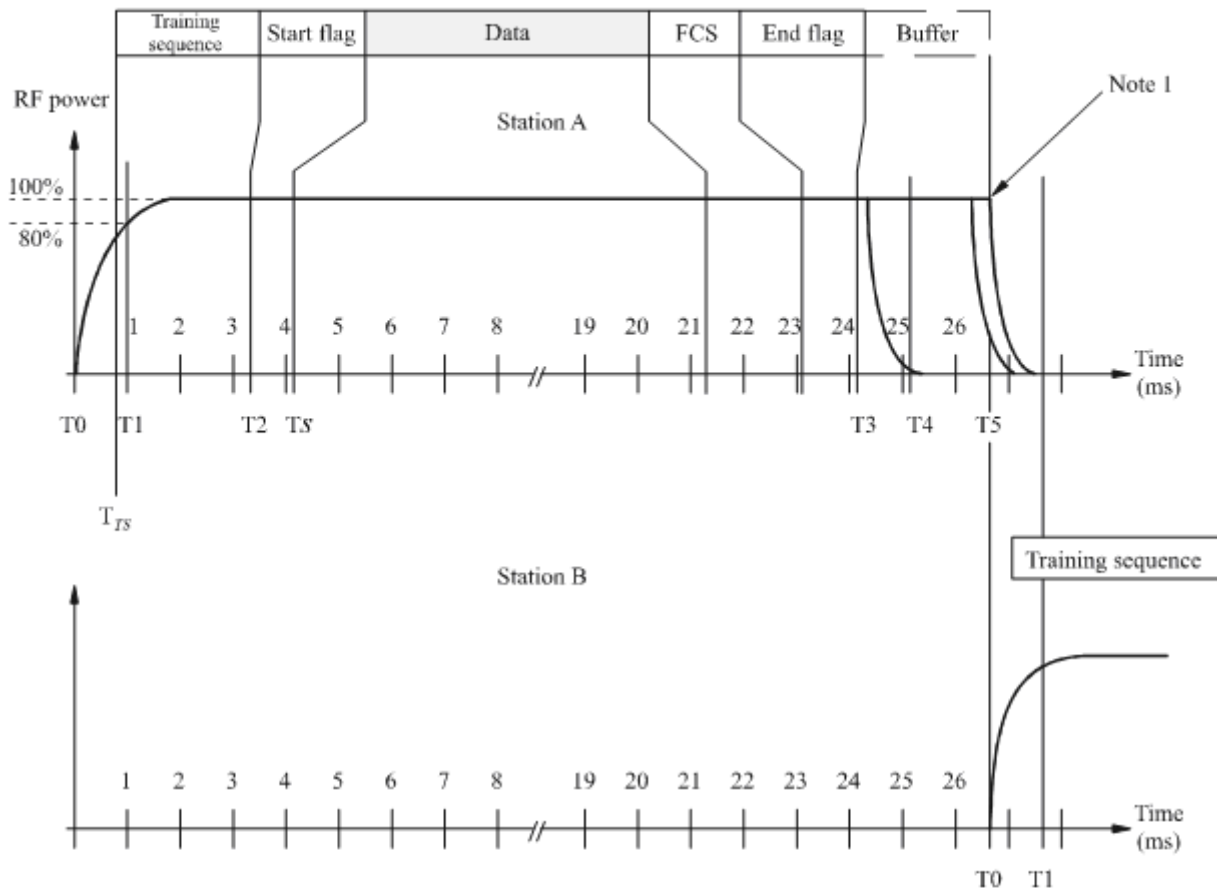

T(n)	Time (ms)	Description
T0	0.000	Slot start. RF power is applied
T _{TS}	0.833	Beginning of training sequence
T1	1.000	RF power and frequency stabilization time
T2	3.333	Start of transmission packet (start flag). This event can be used as a secondary synchronization source should the primary source (UTC) be lost
T _s	4.167	Slot phase synchronization marker. End of start flag, beginning of data
T3	24.167	End of transmission, assuming zero bit stuffing. No modulation is applied after termination of transmission. In case of a shorter data block, the transmission may end earlier
T4	T3 + 1.000	The time when RF power should have reached zero
T5	26.667	End of slot. Beginning of next slot

Note 1 – Should a transmission end exactly at the beginning of the next slot, the Tx-down period for station A will overlap into the next slot as shown in Fig. 8. Transmission of the training sequence is not impaired by this. This occasion would be extremely rare, and it would occur only in the event of a propagation anomaly. Even in this case, the operation of the AIS is not impaired due to the range discrimination characteristics of the receiver.

When selecting among candidate slots for transmission in one channel, the slot usage of other channels should be considered. If the candidate slot in the other channel is used by another station, the use of the slot should follow the same rules as for slot reuse (see § 4.4.1). If a slot in either channel is occupied by or allocated by other base station or mobile station, that slot should be reused only in accordance with § 4.4.1.

The slots of another station, whose navigational status is not set to “at anchor” or “moored” and has not been received for 3 min, should be used as candidate slots for intentional slot reuse.

The own station is unable to transmit on an adjacent slot on the two parallel channels because of the necessary switching time (see § 2.11.1). Thus, the two adjacent slots on either side of a slot that is being used by the own station on one channel should not be considered as candidate slots on the other channel.

The purpose of intentionally reusing slots and maintaining a minimum of four candidate slots within the same probability of being used for transmission is to provide high probability of access to the link. To further provide high probability of access, time-out characteristics are applied to the use of the slots so that slots will continuously become available for new use.

Figure 9 illustrates the process of selecting among candidate slots for transmission on the link.

FIGURE 9

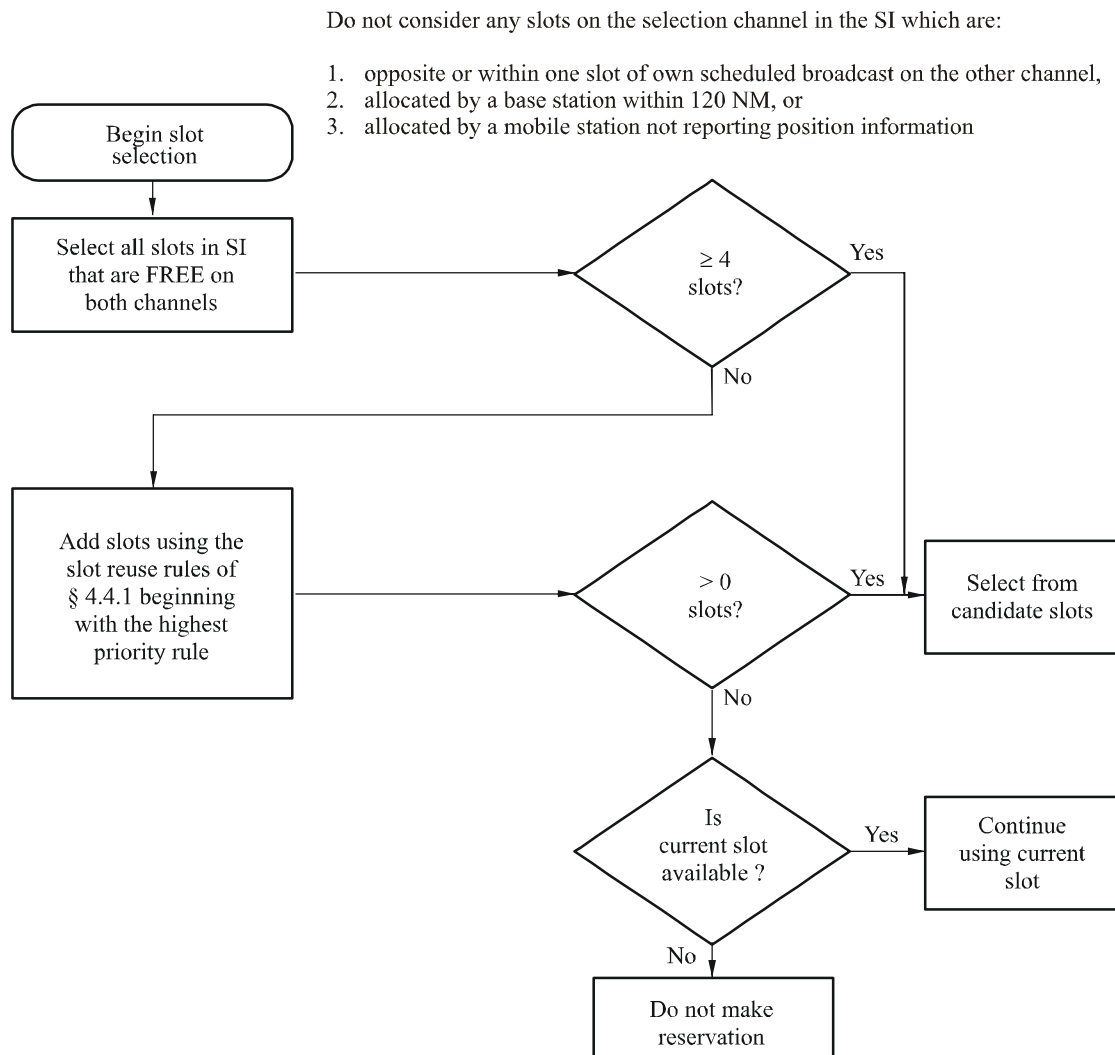

3.3.2 Modes of operation

There should be three modes of operation. The default mode should be autonomous and may be switched to/from other modes. For a simplex repeater there should only be two modes of operation: autonomous and assigned, but no polled mode.

3.3.2.1 Autonomous and continuous

A station operating autonomously should determine its own schedule for transmission. The station should automatically resolve scheduling conflicts with other stations.

3.3.2.2 Assigned

A station operating in the assigned mode takes into account the transmission schedule of the assigning message when determining when it should transmit (see § 3.3.6).

3.3.2.3 Polled

A station operating in polled mode should automatically respond to interrogation messages (Message 15). Operation in the polled mode should not conflict with operation in the other two modes. The response should be transmitted on the channel where the interrogation message was received.

3.3.3 Initialisation

At power on, a station should monitor the TDMA channels for one (1) min to determine channel activity, other participating member IDs, current slot assignments and reported positions of other users, and possible existence of shore stations. During this time period, a dynamic directory of all stations operating in the system should be established. A frame map should be constructed, which reflects TDMA channel activity. After one (1) min has elapsed, the station should enter the operational mode and start to transmit according to its own schedule.

3.3.4 Channel access schemes

The access schemes, as defined below, should coexist and operate simultaneously on the TDMA channel.

3.3.4.1 Incremental TDMA – ITDMA

The ITDMA access scheme allows a station to pre-announce transmission slots of non-repeatable character, with one exception: during data link network entry, ITDMA slots should be marked so that they are reserved for one additional frame. This allows a station to pre-announce its allocations for autonomous and continuous operation.

ITDMA should be used on three occasions:

- data link network entry,
- temporary changes and transitions in periodical reporting intervals,
- pre-announcement of safety related messages.

3.3.4.1.1 ITDMA access algorithm

A station can begin its ITDMA transmission by either substituting a SOTDMA allocated slot or, by allocating a new, unannounced slot, using RATDMA. Either way, this becomes the first ITDMA slot.

The first transmission slot, during data link network entry, should be allocated using RATDMA. That slot should then be used as the first ITDMA transmission.

When higher layers dictate a temporary change of reporting interval or the need to transmit a safety related message, the next scheduled SOTDMA slot may pre-emptively be used for an ITDMA transmission.

Prior to transmitting in the first ITDMA slot, the station randomly selects the next following ITDMA slot and calculates the relative offset to that location. This offset should be inserted into the ITDMA communication state. Receiving stations will be able to mark the slot, indicated by this offset, as externally allocated (see § 3.3.7.3.2 and § 3.1.5). The communication state is transmitted as a part of the ITDMA transmission. During network entry, the station also indicates that the ITDMA slots should be reserved for one additional frame. The process of allocating slots continues as long as required. In the last ITDMA slot, the relative offset is set to zero.

3.3.4.1.2 ITDMA parameters

The parameters of Table 13 control ITDMA scheduling:

TABLE 13

Symbol	Name	Description	Minimum	Maximum
LME.ITINC	Slot increment	The slot increment is used to allocate a slot ahead in the frame. It is a relative offset from the current transmission slot. If it is set to zero, no more ITDMA allocations should be done	0	8 191
LME.ITSL	Number of slots	Indicates the number of consecutive slots, which are allocated, starting at the slot increment	1	5
LME.ITKP	Keep flag	This flag should be set to TRUE when the present slot(s) should be reserved in the next frame also. The keep flag is set to FALSE when the allocated slot should be freed immediately after transmission	False = 0	True = 1

3.3.4.2 Random access TDMA – RATDMA

RATDMA is used when a station needs to allocate a slot, which has not been pre-announced. This is generally done for the first transmission slot during data link network entry, or for messages of a non-repeatable character.

3.3.4.2.1 RATDMA algorithm

The RATDMA access scheme should use a probability persistent (p-persistent) algorithm as described in this paragraph (see Table 14).

An AIS station should avoid using RATDMA. A scheduled message should primarily be used to announce a future transmission to avoid RATDMA transmissions.

Messages, which use the RATDMA access scheme, are stored in a priority first-in first-out (FIFO). When a candidate slot (see § 3.3.1.2) is detected, the station randomly select a probability value (LME.RTP1) between 0 and 100. This value should be compared with the current probability for transmission (LME.RTP2). If LME.RTP1 is equal to, or less than LME.RTP2, transmission should occur in the candidate slot. If not, LME.RTP2 should be incremented with a probability increment (LME.RTP1) and the station should wait for the next candidate slot in the frame.

The SI for RATDMA should be 150 time slots, which is equivalent to 4 s. The candidate slot set should be chosen within the SI, so that the transmission occurs within 4 s.

Each time that a candidate slot is entered, the p-persistent algorithm is applied. If the algorithm determines that a transmission shall be inhibited, then the parameter LME.RTCSC is decremented by one and LME.RTA is incremented by one.

LME.RTCSC can also be decremented as a result of another station allocating a slot in the candidate set. If $LME.RTCSC + LME.RTA < 4$ then the candidate set shall be complemented with a new slot within the range of the current slot and LME.RTES following the slot selection criteria.

3.3.4.2.2 RATDMA parameters

The parameters of Table 14 control RATDMA scheduling:

TABLE 14

Symbol	Name	Description	Minimum	Maximum
LME.RTCSC	Candidate slot counter	The number of slots currently available in the candidate set. NOTE 1 – The initial value is always 4 or more (see § 3.3.1.2). However, during the cycle of the p-persistent algorithm the value may be reduced below 4	1	150
LME.RTES	End slot	Defined as the slot number of the last slot in the initial SI, which is 150 slots ahead	0	2 249
LME.RTPRI	Priority	The priority that the transmission has when queuing messages. The priority is highest when LME.RTPRI is lowest. Safety related messages should have highest service priority (refer to § 4.2.3)	1	0
LME.RTPS	Start probability	Each time a new message is due for transmission, LME.RTP2 should be set equal to LME.RTPS. LME.RTPS shall be equal to $100/LME.RTCSC$. NOTE 2 – LME.RTCSC is set to 4 or more initially. Therefore LME.RTPS has a maximum value of $-25 (100/4)$	0	25
LME.RTP1	Derived probability	Calculated probability for transmission in the next candidate slot. It should be less than or equal to LME.RTP2 for transmission to occur, and it should be randomly selected for each transmission attempt	0	100
LME.RTP2	Current probability	The current probability that a transmission will occur in the next candidate slot	LME.RTPS	100
LME.RTA	Number of attempts	Initial value set to 0. This value is incremented by one each time the p-persistent algorithm determines that a transmission shall not occur	0	149
LME.RTPI	Probability increment	Each time the algorithm determines that transmission should not occur, LME.RTP2 should be incremented with LME.RTPI. LME.RTPI shall be equal to $(100 - LME.RTP2)/LME.RTCSC$	1	25

3.3.4.3 Fixed access TDMA – FATDMA

FATDMA should be used by base stations only. FATDMA allocated slots should be used for repetitive messages. For base stations use of FATDMA refer to § 4.5 and § 4.6.

3.3.4.3.1 FATDMA algorithm

Access to the data link should be achieved with reference to frame start. Each allocation should be pre-configured by the competent authority and not changed for the duration of the operation of the station, or until re-configured. Except where the time-out value is otherwise determined, receivers of data link management message (Message 20) should set a slot time-out value in order to determine when the FATDMA slot will become free. The slot time-out should be reset with each reception of the message.

FATDMA reservations should consist of a base station report (message 4) in conjunction with a data link management message with the same base station ID (MMSI). FATDMA reservations apply within a range of 120 nautical miles from the reserving base station. AIS stations (except when using FATDMA) should not use FATDMA reserved slots within this range. A data link management message (Message 20) without a base station report (Message 4) should be ignored. Base stations may reuse FATDMA reserved slots within this range for their own FATDMA transmissions but may not reuse FATDMA reserved slots for RATDMA transmissions.

FATDMA reservations do not apply beyond 120 nautical miles from the reserving base station. All stations may consider these slots as available.

3.3.4.3.2 FATDMA parameters

The parameters of Table 15 control FATDMA scheduling:

TABLE 15

Symbol	Name	Description	Minimum	Maximum
LME.FTST	Start slot	The first slot (referenced to frame start) to be used by the station	0	2 249
LME.FTI	Increment	Increment to next block of allocated slots. An increment of zero indicates that the station transmits one time per frame, in the start slot	0	1 125
LME.FTBS	Block size	Default block size. Determines the default number of consecutive slots which are to be reserved at each increment	1	5

3.3.4.4 Self-organizing TDMA – SOTDMA

The SOTDMA access scheme should be used by mobile stations operating in autonomous and continuous mode, or in the assigned mode (see Table 43, Annex 8). The purpose of the access scheme is to offer an access algorithm which quickly resolves conflicts without intervention from controlling stations. Messages which use the SOTDMA access scheme are of a repeatable character and are used in order to supply a continuously updated surveillance picture to other users of the data link.

3.3.4.4.1 SOTDMA algorithm

The access algorithm and continuous operation of SOTDMA is described in § 3.3.5.

3.3.4.4.2 SOTDMA parameters

The parameters of Table 16 control SOTDMA scheduling:

TABLE 16

Symbol	Name	Description	Minimum	Maximum
NSS	Nominal start slot	This is the first slot used by a station to announce itself on the data link. Other repeatable transmissions are generally selected with the NSS as a reference. When transmissions with the same reporting rate (R_r) are made using two channels (A and B), the NSS for the second channel (B) is offset from the first channel's NSS by NI: $NSS_B = NSS_A + NI$	0	2 249
NS	Nominal slot	The nominal slot is used as the centre around which slots are selected for transmission of position reports. For the first transmission in a frame, the NSS and NS are equal. The NS when using only one channel is: $NS = NSS + (n \times NI); (0 \leq n < R_r)$ When transmissions are made using two channels (A and B), the slot separation between the nominal slots on each channel is doubled and offset by NI: $NS_A = NSS_A + (n \times 2 \times NI)$ where: $0 \leq n < 0.5 \times R_r$ $NS_B = NSS_A + NI + (n \times 2 \times NI)$ where: $0 \leq n < 0.5 \times R_r$	0	2 249
NI	Nominal increment	The nominal increment is given in number of slots and is derived using the equation below: $NI = 2\,250/R_r$	75 ⁽¹⁾	1 225
R _r	Report rate	This is the desired number of position reports per minute. $R_r = 60/RI$; (where RI is the reporting interval (s))	2 ^{(2), (3)}	30 ⁽⁴⁾
SI	Selection interval	The SI is the collection of slots which can be candidates for position reports. The SI is derived using the equation below: $SI = \{NS - (0.1 \times NI) \text{ to } NS + (0.1 \times NI)\}$	$0.2 \times NI$	$0.2 \times NI$

TABLE 16 (*end*)

Symbol	Name	Description	Minimum	Maximum
NTS	Nominal transmission slot	The slot, within a selection interval, currently used for transmissions within that interval	0	2 249
TMO_MIN	Minimum time-out	The minimum SOTDMA slot time-out	3 frames	NA
TMO_MAX	Maximum time-out	The maximum SOTDMA slot time-out	NA	7 frames

- (1) 37.5 when operating in the assigned mode using report rate assignment; 45 when operating in the assigned mode using slot increment assignment and the SOTDMA communication state.
- (2) When a station uses a report rate of less than two reports per min, ITDMA allocations should be used.
- (3) Also when operating in the assigned mode using SOTDMA as given by Table 43, Annex 8.
- (4) Sixty reports per min when operating in the assigned mode using SOTDMA as given by Table 43, Annex 8.

3.3.5 Autonomous and continuous operation

This section describes how a station operates in the autonomous and continuous mode. Figure 10 shows the slot map accessed using SOTDMA.

FIGURE 10
Uniform reporting rate using two channels

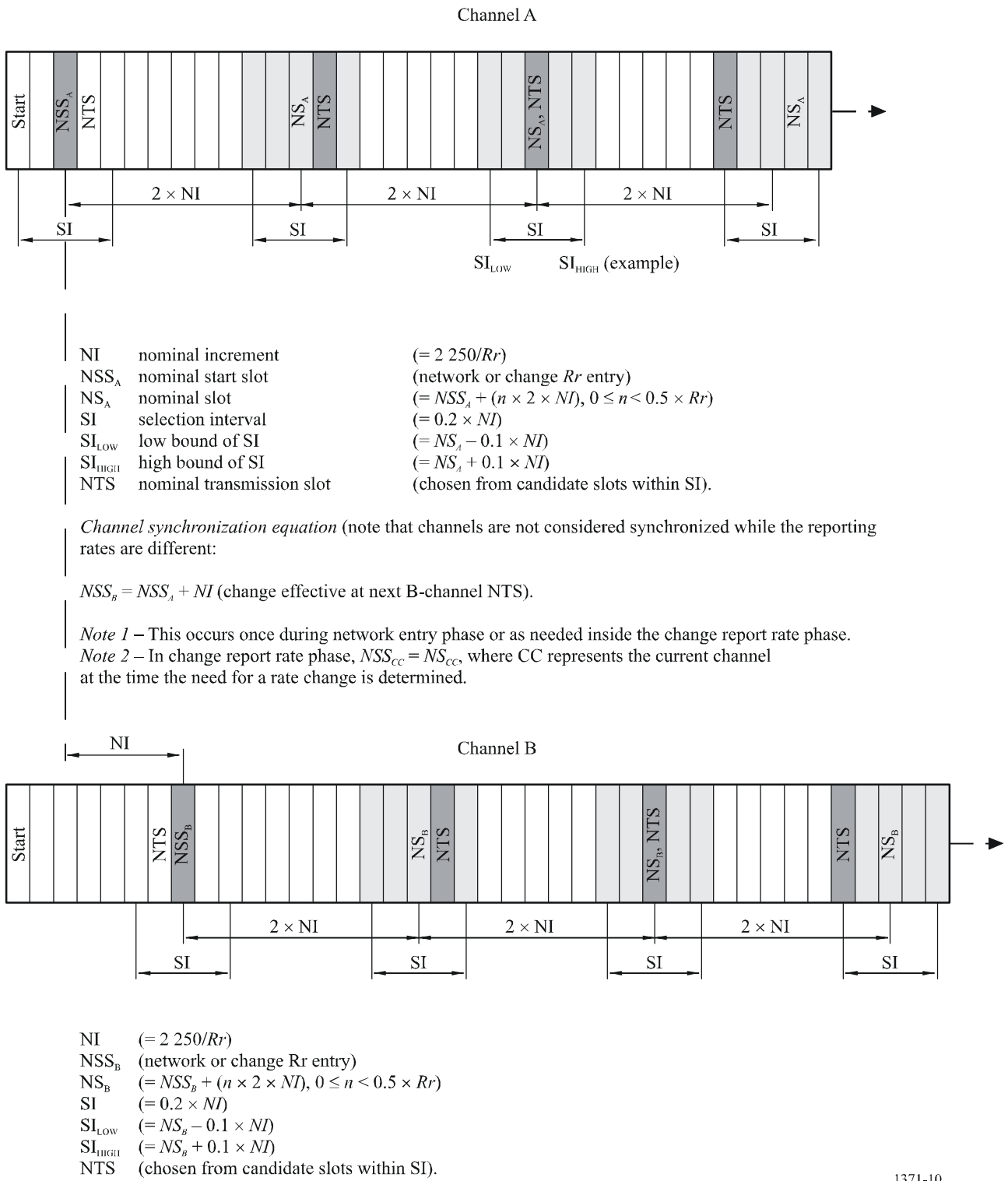

3.3.5.1 Initialization phase

The initialization phase is described using the flowchart shown in Fig. 11.

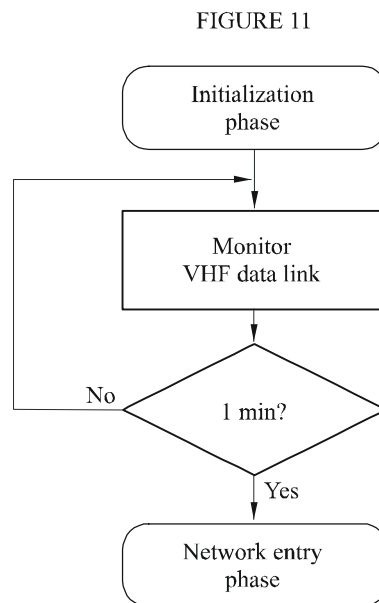

1371-11

3.3.5.1.1 Monitor VHF data link

At power on, a station should monitor the TDMA channel for one (1) min interval to determine channel activity, other participating member IDs, current slot assignments and reported positions of other users, and possible existence of base stations. During this time period, a dynamic directory of all members operating in the system should be established. A frame map should be constructed, which reflects TDMA channel activity.

3.3.5.1.2 Network entry after one minute

After one (1) min interval has elapsed, the station should enter the network and start to transmit according to its own schedule, as described below.

3.3.5.2 Network entry phase

During the network entry phase, the station should select its first slot for transmission in order to make itself visible to other participating stations. The first transmission of a Class A mobile station should always be the special position report (Message 3, see Fig. 12).

FIGURE 12

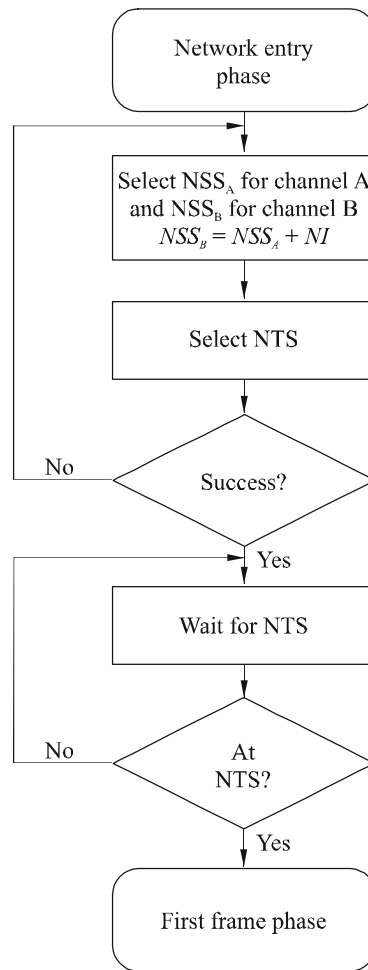

1371-12

3.3.5.2.1 Select nominal start slot

The nominal start slot (NSS) should be randomly selected between current slot and nominal increment (NI) slots forward. This slot should be the reference when selecting nominal slots (NS) during the first frame phase. The first NS should always be equal to NSS.

3.3.5.2.2 Select nominal transmission slot

Within the SOTDMA algorithm, the nominal transmission slot (NTS) should be randomly selected among candidate slots within the SI. This is the NTS, which should be marked as internally allocated and assigned a random time-out between and including TMO_MIN and TMO_MAX.

3.3.5.2.3 Wait for NTS

The station should wait until the NTS is approached.

3.3.5.2.4 At NTS

When the frame map indicates that the NTS is approaching, the station should enter the first frame phase.

3.3.5.3 First frame phase

During the first frame phase which is equal to a 1 min interval, the station should continuously allocate its transmission slots and transmit special position reports (Message 3) using ITDMA (see Fig. 13).

FIGURE 13

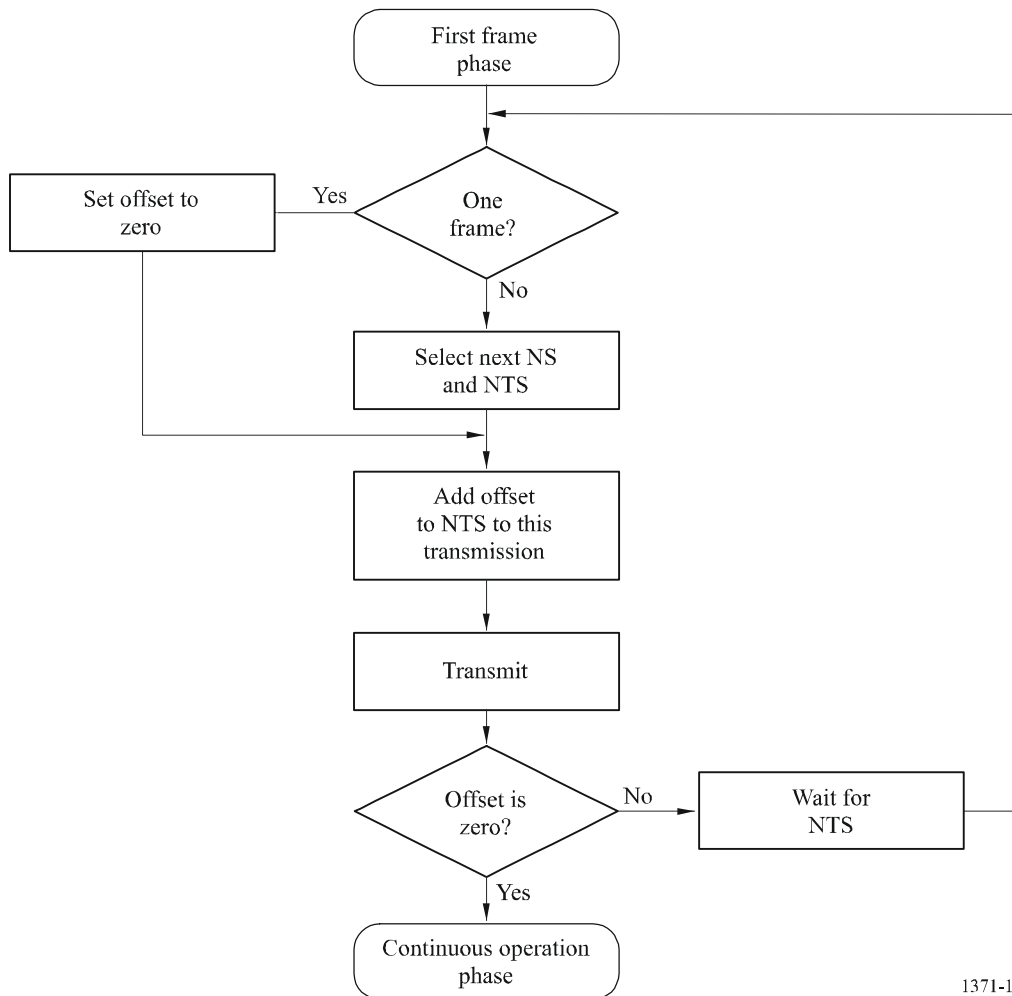

1371-13

3.3.5.3.1 Normal operation after one frame

When a 1 min interval has elapsed, the initial transmissions should have been allocated and normal operation should commence.

3.3.5.3.2 Set offset to zero

When all allocations have been made after one frame, the offset should be set to zero in the last transmission to indicate that no more allocations will be made.

3.3.5.3.3 Select next NS and NTS

Prior to transmitting, the next NS should be selected. This should be done by keeping track of the number of transmissions performed so far on the channel (from n to $Rr - 1$). The NS should be selected using the equation described in Table 16.

Nominal transmission slot should be selected using the SOTDMA algorithm to select among candidate slots within SI. The NTS should then be marked as internally allocated. The offset to next NTS should be calculated and saved for the next step.

3.3.5.3.4 Add offset to this transmission

All transmissions in the first frame phase should use the ITDMA access scheme. This structure contains an offset from the current transmission to the next slot in which a transmission is due to occur. The transmission also sets the keep flag so that receiving stations will allocate the occupied slot for one additional frame.

3.3.5.3.5 Transmit

A scheduled position report should be entered into the ITDMA packet and transmitted in the allocated slot. The slot time-out of this slot should be decremented by one.

3.3.5.3.6 Offset is zero

If the offset has been set to zero, the first frame phase should be considered to have ended. The station should now enter the continuous operation phase.

3.3.5.3.7 Wait for NTS

If the offset was non-zero, the station should wait for the next NTS and repeat the sequence.

3.3.5.4 Continuous operation phase

The station should remain in the continuous operation phase until it shuts down, enters assigned mode or is changing its reporting interval (see Fig. 14).

FIGURE 14

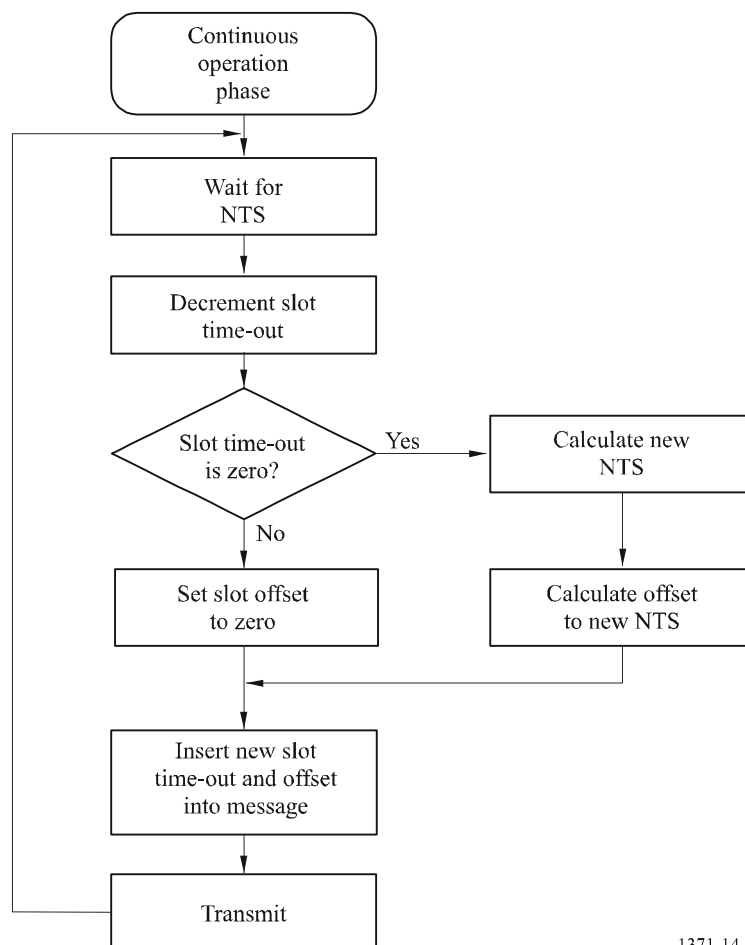

3.3.5.4.1 Wait for NTS

The station should now wait until this slot is approached.

3.3.5.4.2 Decrement slot time-out

Upon reaching the NTS, the SOTDMA time-out counter, for that slot, should be decremented. This slot time-out specifies how many frames the slot is allocated for. The slot time-out should always be included as part of the SOTDMA transmission.

3.3.5.4.3 Slot time-out is zero

If the slot time-out is zero, a new NTS should be selected. The SI around the NS should be searched for candidate slots and one of the candidates should be randomly selected. The offset from the current NTS and the new NTS should be calculated and assigned as a slot offset value:

$$(\text{slot offset} = \text{NTS}_{\text{new}} - \text{NTS}_{\text{current}} + 2\ 250)$$

The new NTS should be assigned a time-out value with a randomly selected value between and including TMO_MIN and TMO_MAX.

If the slot time-out is more than zero, the slot offset value should be set to zero.

3.3.5.4.4 Assign time-out and offset to packet

The time-out and slot offset values are inserted into the SOTDMA communication state (see § 3.3.7.2.1).

3.3.5.4.5 Transmit

A scheduled position report is inserted into the SOTDMA packet and transmitted in the allocated slot. The slot time-out should be decremented by one. The station should then wait for the next NTS.

3.3.5.5 Changing reporting interval

When the nominal reporting interval is required to change, the station should enter change reporting interval phase (see Fig. 15). During this phase, it will reschedule its periodic transmissions to suit the new desired reporting interval.

The procedure, described in this section, should be used for changes which will persist for at least 2 frames. For temporary changes, ITDMA transmissions should be inserted between SOTDMA transmissions for the duration of the change.

3.3.5.5.1 Wait for next transmit slot

Prior to changing its reporting interval, the station should wait for the next slot, which has been allocated for own transmission. Upon reaching this slot, the associated NS is set to the new NSS. The slot, which was allocated for own transmission, should be checked to make sure that the slot time-out is non-zero. If it is zero, the slot time-out should be set to one.

3.3.5.5.2 Scan next SI

When using the new reporting interval, a new NI should be derived. With the new NI, the station should examine the area which is covered by the next SI. If a slot is found, which is allocated for own transmission, it should be checked to see if it is associated with the NSS. If so, the phase is complete and the station should return to normal operation. If not, the slot should be kept with a time-out above zero.

If a slot was not found within the SI, a slot should be allocated. The offset, in slots, between the current transmit slot and the new allocated slot, should be calculated. The current transmit slot should be converted into an ITDMA transmission which should hold the offset with the keep flag set to TRUE.

The current slot should then be used for transmission of periodic messages such as a position report.

FIGURE 15

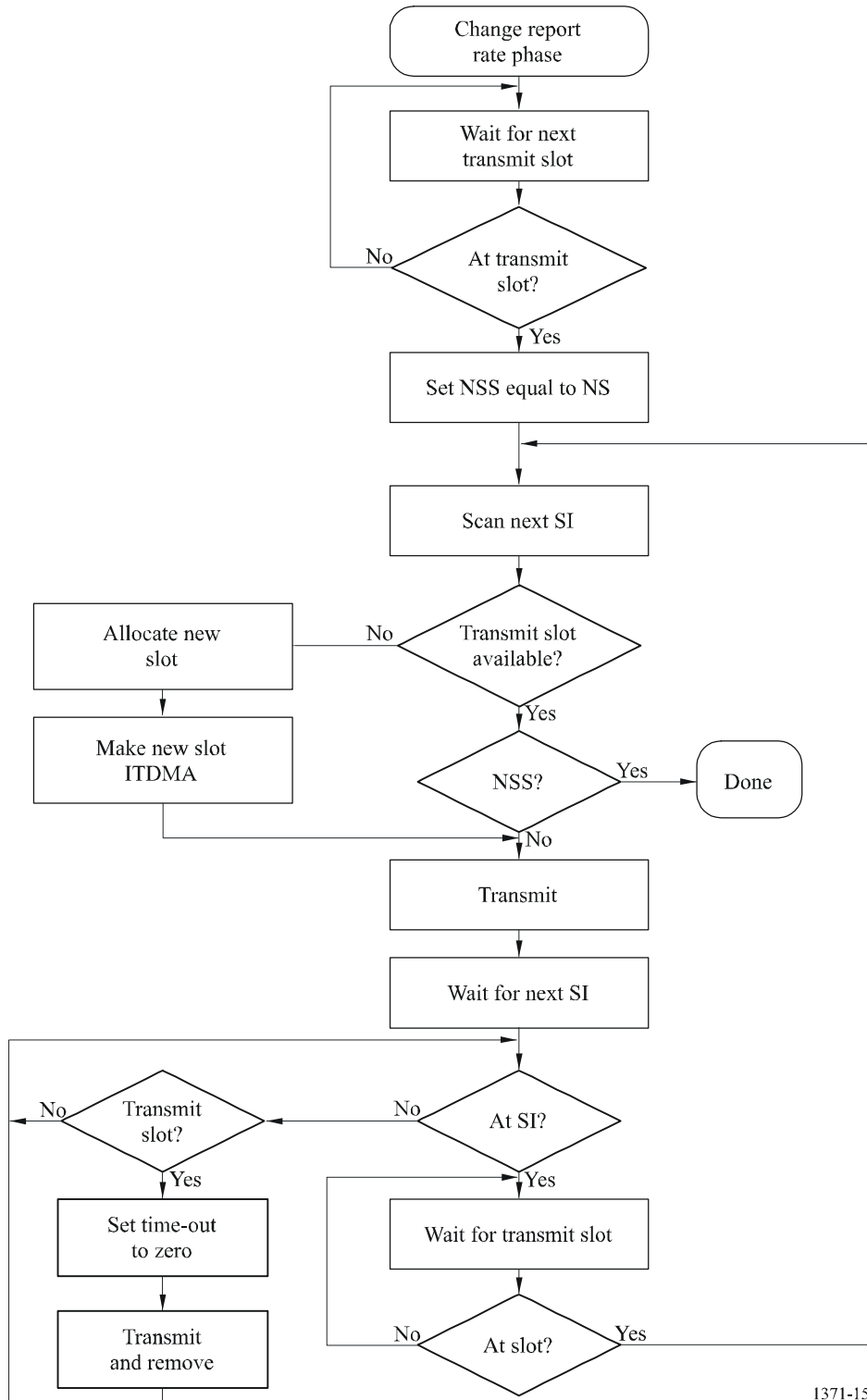

3.3.5.5.3 Wait for next SI

While waiting for the next SI, the station continuously scans the frame for slots which are allocated for own transmission. If a slot is found, the slot time-out should be set to zero. After transmission in that slot, the slot should be freed.

When the next SI is approached, the station should begin to search for the transmit slot allocated within the SI. When found, the process should be repeated.

3.3.6 Assigned operation

If a mobile station is outside and not entering a transition zone, a station operating in the autonomous mode, may be commanded to operate according to a specific transmission schedule as defined in Message 16 or 23. Assigned mode applies to alternating operation between both channels.

When operating in the assigned mode, the Class B “SO” shipborne mobile station and the search and rescue (SAR) aircraft station should set their assign mode flag to “station operating in assigned mode”. The assigned mode should affect only the station’s transmission of position reports, and no other behaviour of the station should be affected. Mobile stations, other than Class A should transmit position reports as directed by Message 16 or 23, and the station should not change its reporting interval for changing course and speed.

Class A shipborne mobile AIS stations should apply the same rule unless the autonomous mode requires a shorter reporting interval than the reporting interval as directed by Message 16 or 23. When operating in the assigned mode, the Class A shipborne mobile station should use Message 2 for transmission of position reports instead of Message 1.

If the autonomous mode requires a shorter reporting interval than that directed by Message 16 or 23, the Class A shipborne mobile AIS station should use the reporting interval of the autonomous mode. If a temporary change of the autonomous reporting interval requires a shorter reporting interval than that directed by Message 16 or 23, ITDMA transmissions should be inserted between the assigned transmissions for the duration of the change. If a slot offset is given, it should be relative to the assignment transmission received. Assignments are limited in time and will be re-issued by the competent authority as needed. The last received assignment should continue or overwrite the previous assignment. This should also be the case, when two assignments are made in the same Message 16 for the same station. Two levels of assignments are possible.

3.3.6.1 Assignment of reporting interval

When assigned a new RI, the mobile station should continue to autonomously schedule its transmissions according to the rules of § 3.3.6. The process of changing to a new RI is described in § 4.3.

3.3.6.2 Assignment of transmission slots

A station may be assigned the exact slots to be used for repeatable transmissions by a base station using the assigned mode command Message 16 (see § 4.5).

3.3.6.2.1 Entering assigned mode

Upon receipt of the assigned mode command Message 16, the station should allocate the specified slots and begin transmission in these. It should continue to transmit in the autonomously allocated slots with a zero slot time-out and a zero slot offset, until those slots have been removed from the transmission schedule. A transmission with a zero slot time-out and a zero slot offset indicates that this is the last transmission in that slot with no further allocation in that SI.

3.3.6.2.2 Operating in the assigned mode

The assigned slots should use the SOTDMA communication state, with the time-out value set to the time-out of the assigned slot. The assigned slot time-out should be between 3 and 7 for all assigned slots. For each frame, the slot time-out should be decremented.

3.3.6.2.3 Returning to autonomous and continuous mode

Unless a new assignment is received, the assignment should be terminated, when the slot time-out reaches zero. At this stage, the station should return to autonomous and continuous mode.

The station should initiate the return to autonomous and continuous mode as soon as it detects an assigned slot with a zero slot time-out. This slot should be used to re-enter the network. The station should randomly select an available slot from candidate slots within a NI of the current slot and make this the NSS. It should then substitute the assigned slot for an ITDMA slot and should use this to transmit the relative offset to the new NSS. From this point on, the process should be identical to the network entry phase (see § 3.3.5.2).

3.3.7 Message structure

Messages, which are part of the access schemes, should have the following structure shown in Fig. 16 inside the data portion of a data packet:

FIGURE 16

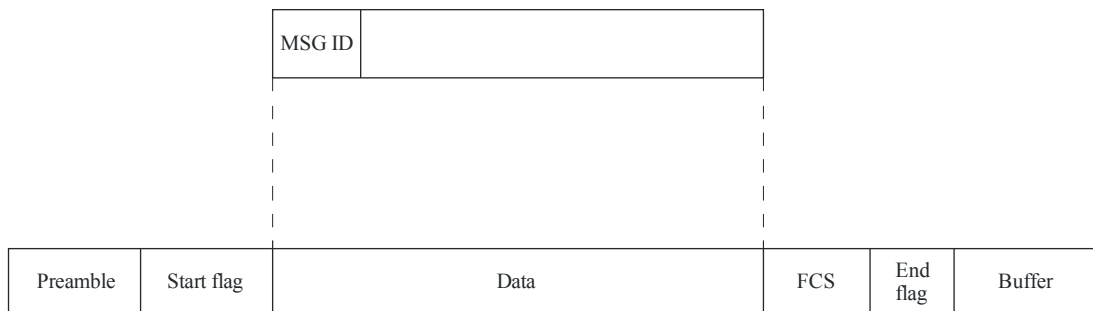

1371-16

Each message is described using a table with parameter fields listed from top to bottom. Each parameter field is defined with the most significant bit first.

Parameter fields containing sub-fields (e.g. communication state) are defined in separate tables with sub-fields listed top to bottom, with the most significant bit first within each sub-field.

Character strings are presented left to right most significant bit first. All unused characters should be represented by the @ symbol, and they should be placed at the end of the string.

When data is output on the VHF data link it should be grouped in bytes of 8 bits from top to bottom of the table associated with each message in accordance with ISO/IEC 3309: 1993. Each byte should be output with least significant bit first. During the output process, data should be subject to bit-stuffing (see § 3.2.2) and NRZI coding (see § 2.6).

Unused bits in the last byte should be set to zero in order to preserve byte boundary.

Generic example for a message table:

TABLE 17

Parameter	Symbol	Number of bits	Description
P1	T	6	Parameter 1
P2	D	1	Parameter 2
P3	I	1	Parameter 3
P4	M	27	Parameter 4
P5	N	2	Parameter 5
Unused	0	3	Unused bits

Logical view of data as described in § 3.3.7:

Bit order	M----L--	M-----	-----	-----	--LML000
Symbol	TTTTTTDI	MMMMMMMM	MMMMMMMM	MMMMMMMM	MMMNNO00
Byte order	1	2	3	4	5

Output order to VHF data link (bit-stuffing is disregarded in the example):

Bit order	--L----M	-----M	-----	-----	000LML--
Symbol	IDTTTTTTT	MMMMMMMM	MMMMMMMM	MMMMMMMM	000NNMMM
Byte order	1	2	3	4	5

3.3.7.1 Message ID (MSG ID)

The message ID should be 6 bits long and should range between 0 and 63. The message ID should identify the message type.

3.3.7.2 SOTDMA message structure

The SOTDMA message structure should supply the necessary information in order to operate in accordance with § 3.3.4.4. The message structure is shown in Fig. 17.

FIGURE 17

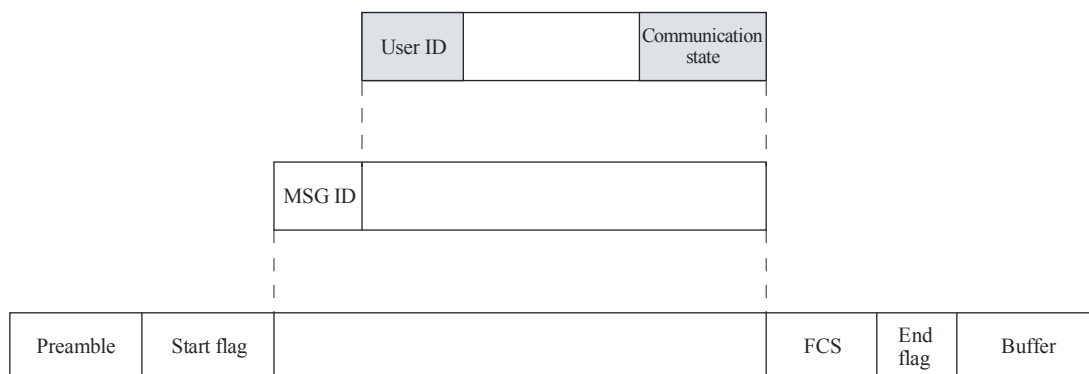

3.3.7.2.1 User ID

The user ID should be the MMSI (see § 3, Annex 1). The MMSI is 30 bits long. The first 9 digits (most significant digits) should be used only.

3.3.7.2.2 SOTDMA communication state

The communication state provides the following functions:

- it contains information used by the slot allocation algorithm in the SOTDMA concept;
- it also indicates the synchronization state.

The SOTDMA communication state is structured as shown in Table 18:

TABLE 18

Parameter	Number of bits	Description
Sync state	2	0 UTC direct (see § 3.1.1.1) 1 UTC indirect (see § 3.1.1.2) 2 Station is synchronized to a base station (base direct) (see § 3.1.1.3) 3 Station is synchronized to another station based on the highest number of received stations or to another mobile station, which is directly synchronized to a base station (see § 3.1.1.3 and § 3.1.1.4)
Slot time-out	3	Specifies frames remaining until a new slot is selected 0 means that this was the last transmission in this slot 1-7 means that 1 to 7 frames respectively are left until slot change
Sub message	14	The sub message depends on the current value in slot time-out as described in Table 19

The SOTDMA communication state should apply only to the slot in the channel where the relevant transmission occurs.

3.3.7.2.3 Sub messages

TABLE 19

Slot time-out	Sub message	Description
3, 5, 7	Received stations	Number of other stations (not own station) which the station currently is receiving (between 0 and 16 383).
2, 4, 6	Slot number	Slot number used for this transmission (between 0 and 2 249).
1	UTC hour and minute	If the station has access to UTC, the hour and minute should be indicated in this sub message. Hour (0-23) should be coded in bits 13 to 9 of the sub message (bit 13 is MSB). Minute (0-59) should be coded in bit 8 to 2 (bit 8 is MSB). Bit 1 and bit 0 are not used.
0	Slot offset	If the slot time-out value is 0 (zero) then the slot offset should indicate the offset to the slot in which transmission will occur during the next frame. If the slot offset is zero, the slot should be de-allocated after transmission.

3.3.7.3 ITDMA message structure

The ITDMA message structure supplies the necessary information in order to operate in accordance with § 3.3.4.1. The message structure is shown in Fig. 18:

FIGURE 18

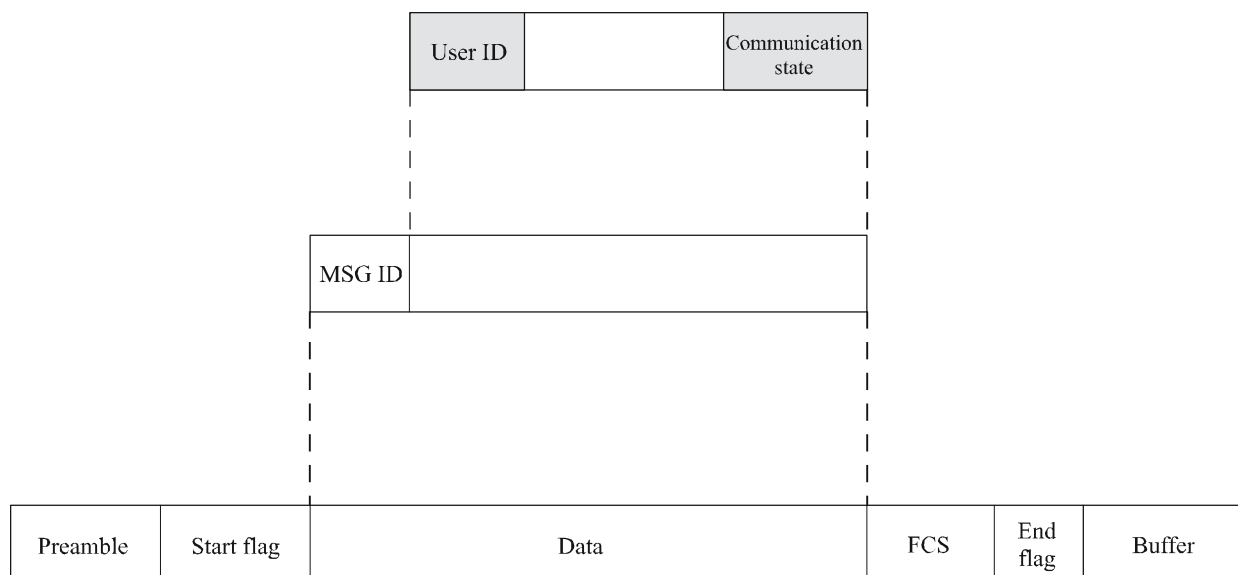

1371-18

3.3.7.3.1 User ID

The user ID should be the MMSI (see § 3, Annex 1). The MMSI is 30 bits long. The first 9 digits (most significant digits) should be used only.

3.3.7.3.2 ITDMA communication state

The communication state provides the following functions:

- it contains information used by the slot allocation algorithm in the ITDMA concept;
- it also indicates the synchronization state.

The ITDMA communication state is structured as shown in Table 20:

TABLE 20

Parameter	Number of bits	Description
Sync state	2	0 UTC direct (see § 3.1.1.1) 1 UTC indirect (see § 3.1.1.2) 2 Station is synchronized to a base station (base direct) (see § 3.1.1.3) 3 Station is synchronized to another station based on the highest number of received stations or to another mobile station, which is directly synchronized to a base station (see § 3.1.1.3 and § 3.1.1.4)
Slot increment	13	Offset to next slot to be used, or zero (0) if no more transmissions

TABLE 20 (*end*)

Parameter	Number of bits	Description
Number of slots	3	Number of consecutive slots to allocate. 0 = 1 slot, 1 = 2 slots, 2 = 3 slots, 3 = 4 slots, 4 = 5 slots, 5 = 1 slot; offset = slot increment + 8 192, 6 = 2 slots; offset = slot increment + 8 192, 7 = 3 slots; offset = slot increment + 8 192. Use of 5 to 7 removes the need for RATDMA broadcast for scheduled transmissions up to 6 min intervals
Keep flag	1	Set to TRUE = 1 if the slot remains allocated for one additional frame (see Table 13)

The ITDMA communication state should apply only to the slot in the channel where the relevant transmission occurs.

3.3.7.4 RATDMA message structure

The RATDMA access scheme may use message structures determined by message ID and may thus lack a uniform structure.

A message with a communication state may be transmitted using RATDMA in the following situations:

- When initially entering the network (refer to § 3.3.4.1.1).
- When repeating a message.

3.3.7.4.1 The communication state when initially entering the network should be set in accordance with § 3.3.4.1.1 and § 3.3.7.3.2.

3.3.7.4.2 The communication state when repeating a message should be set in accordance with § 4.6.3.

3.3.7.5 FATDMA message structure

The FATDMA access scheme may use message structures determined by message ID and may thus lack a uniform structure.

A message with a communication state may be transmitted using FATDMA, e.g. when repeated. In this situation, the communication state should be set in accordance with § 4.6.3 (see also § 3.16, Annex 8).

4 Network layer

The network layer should be used for:

- establishing and maintaining channel connections;
- management of priority assignments of messages;
- distribution of transmission packets between channels;
- data link congestion resolution.

4.1 Dual channel operation and channel management

In order to satisfy the requirements for dual channel operation (see § 2.1.4), the following should apply, unless otherwise specified by Message 22.

4.1.1 Operating frequency channels

Two frequency channels have been designated in RR Appendix 18 for AIS use worldwide, on the high seas and in all other areas, unless other frequencies are designated on a regional basis for AIS purposes. The two designated frequencies are:

- AIS 1 (Channel 87B, 161.975 MHz), (2087)¹; and
- AIS 2 (Channel 88B, 162.025 MHz) (2088)¹.

The AIS should default to operation on these channels.

Operation on other channels should be accomplished by the following means: manual input commands (manual switching) from AIS input device, TDMA commands from a base station (automatic switching by TDMA telecommand), digital selective call (DSC) commands from a base station (automatic switching by DSC telecommand) or commands from shipborne systems, e.g. ECDIS or automatic switching by shipborne system command (ENC) via IEC 61162 command. The last eight (8) received regional operating settings including the region itself should be stored by the mobile station. All stored regional operating settings should be time/date-tagged and they should be tagged with information by what input means this regional operating setting was received (TDMA Message 20, DSC telecommand, manual input, input via Presentation Interface).

For channel management when position information is lost during normal operation, the current frequency channel use should be maintained until ordered to change by an addressed channel management message (addressed DSC command or addressed Message 22) or by manual input.

4.1.2 Normal default mode of dual channel operation

The normal default mode of operation should be a two-channel operating mode, where the AIS simultaneously receives on both channels in parallel. In order to accomplish this performance, the AIS transponder should contain two TDMA receivers.

Channel access is performed independently on each of the two parallel channels.

For periodic repeated messages, including the initial link access, the transmissions should alternate between AIS 1 and AIS 2. This alternating behaviour is on a transmission by transmission basis, without respect to time frames.

Transmissions of own station following slot allocation announcements of own station, responses of own station to interrogations, responses of own station to requests, and acknowledgements of own station should be transmitted on the same channel as the initial message received.

For addressed messages, transmissions should utilize the channel in which messages from the addressed station were last received.

For non-periodic messages other than those referenced above, the transmissions of each message, regardless of message type, should alternate between AIS 1 and AIS 2.

¹ See Recommendation ITU-R M.1084, Annex 4.

Base stations could alternate their transmissions between AIS 1 and AIS 2 for the following reasons:

- To increase link capacity.
- To balance channel loading between AIS 1 and AIS 2.
- To mitigate the harmful effects of RF interference.

When a base station is included in a channel management scenario, it should transmit addressed messages on the channel in which it last received a message from the addressed station.

4.1.3 Regional operating frequencies

Regional operating frequencies should be designated by the four-digit channel numbers specified in Recommendation ITU-R M.1084, Annex 4. This allows for simplex, duplex, 25 kHz channels for regional options, subject to the provisions of RR Appendix 18.

4.1.4 Regional operating areas

Regional operating areas should be designated by a Mercator projection rectangle with two reference points (WGS-84). The first reference point should be the geographical coordinate address of the north-eastern corner (to the nearest tenth of a minute) and the second reference point should be the geographical coordinate address of the south-western corner (to the nearest tenth of a minute) of the rectangle.

The channel number designates the use of the channel (simplex, duplex, 25 kHz).

When a station is subject to the regional boundaries, it should immediately set its operating frequency channel numbers, its transmitter/receiver mode and its power level to the values as commanded. When a station is not subject to the regional boundaries, the station should utilize the default settings, which are defined in the following paragraphs:

Power settings:	§ 2.12
Operating frequency channel numbers:	§ 4.1.1
Transmitter/receiver mode:	§ 4.1.2
Transition zone size:	§ 4.1.5

If regional operating areas are used, the areas should be defined in such a way that these areas will be covered completely by transmissions of channel management commands (either TDMA or DSC) from at least one base station.

4.1.5 Transitional mode operations near regional boundaries

The AIS device should automatically switch to the two-channel transitional operating mode when it is located within five nautical miles, or the transitional zone size (see Table 72, Annex 8), of a regional boundary. In this mode the AIS device should transmit and receive on the primary AIS frequency specified for the occupied region; it should also transmit and receive on the primary AIS frequency of the nearest adjacent region. Only one transmitter is required. Additionally, for dual channel operations as specified in § 4.1.2, except when the reporting interval has been assigned by Message 16, when operating in this mode, the reporting interval should be doubled and shared between the two channels (alternate transmission mode). When the AIS is entering the transitional mode, it should continue to utilize the current channels for transmitting for a full one-minute frame while switching one of the receivers to the new channel. The TDMA access rules should be applied to vacating slots on the current channel and accessing slots on the new channel. This transitional behaviour is necessary only when the channels are changing.

Regional boundaries should be established by the competent authority in such a way that this two-channel transitional operating mode can be implemented as simply and safely as possible. For example, care should be taken to avoid having more than three adjacent regions at any regional boundary intersection. In this context the high seas area should be considered to be a region where default operating settings apply. The mobile AIS station should ignore any channel management command, when there are three different regional operating settings with adjacent regional operating areas, their corners within eight nautical miles to each other.

Regions should be as large as possible. For practical purposes, in order to provide safe transitions between regions, these should be no smaller than 20 NM but not larger than 200 NM on any boundary side. Examples of acceptable and unacceptable regional boundary definitions are illustrated in Figs 19 and 20.

FIGURE 19

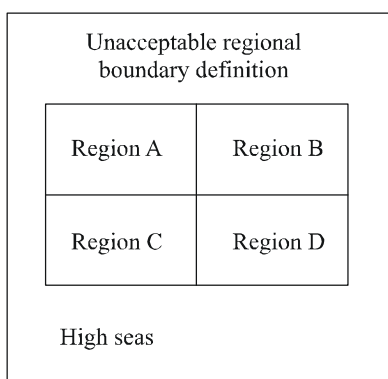
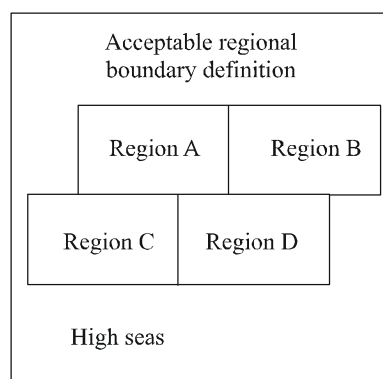

FIGURE 20



1371-1920

4.1.5.1 Changing channel bandwidth

A competent authority should not assign different bandwidths to adjacent regions that use the same frequency or frequencies. To do this an additional buffer region is required. If a buffer region is not used, the assignments would result in an unstable condition with regard to received messages, incorrectly interpreting slots as being free.

4.1.6 Channel management by manual input

Channel management by manual input should include the geographical area along with the designated AIS channel(s) for use in that area (refer to Message 22). Manual input should be subject to override by TDMA command, DSC command or shipborne system command, i.e. via Presentation Interface, in accordance with the rules laid out in § 4.1.8.

When the user requires a manual input of a regional operating setting, the regional operating settings in use, which may be the default operating settings, should be presented to the user. The user should then be allowed to edit these settings partly or in full. The mobile station should ensure that a regional operating area is always input and that it conforms to the rules for regional operating areas (see § 4.1.5). After completion of input of an acceptable regional operating settings set, the AIS should require the user to confirm a second time that the input data should be stored and possibly used instantaneously.

4.1.7 Resumption of operation after power on

After power on, a mobile station should resume operation using the default settings, unless the own position is within any of the stored regions.

In this case, the mobile station should operate using the stored operating settings of that identified region.

4.1.8 Priority of channel management commands and clearing of stored regional operating settings

The most current and applicable commands received should override previous channel management commands in accordance with the following rules:

The mobile AIS station should constantly check, if the nearest boundary of the regional operating area of any stored regional operating setting is more than 500 miles away from the current position of own station, or if any stored regional operating setting was older than five weeks. Any stored regional operating setting which fulfils any one of these conditions should be erased from the memory.

The regional operating settings set should be handled as a whole, i.e. a change requested for any parameter of the regional operating settings should be interpreted as a new regional operating setting.

The mobile AIS station should not accept, i.e. ignore, any new regional operating setting which includes a regional operating area, which does not conform to the rules for regional operating areas laid out in § 4.1.5.

The mobile AIS station should not accept a new regional operating setting which was input to it from a shipborne system command, i.e. via the Presentation Interface, if the regional operating area of this new regional operating setting partly or totally overlaps or matches the regional operating area of any of the stored regional operating settings, which were received from a base station either by Message 22 or by DSC telecommand within the last two hours.

A Message 22 addressed to own station or a DSC telecommand addressed to own station should be accepted only if the mobile AIS station is in a region defined by one of the stored regional operating settings. In this case the set of regional operating settings should be composed by combining the received parameters with the regional operating area in use.

If the regional operating area of the new, accepted regional operating setting overlaps in part or in total or matches the regional operating areas of one or more older regional operating settings, this or these older regional operating settings should be erased from the memory. The regional operating area of the new, accepted regional operating setting may be neighbouring tightly and may thus have the same boundaries as older regional operating settings. This should not lead to the erasure of the older regional operating settings.

Subsequently, the mobile AIS station should store a new, accepted regional operating setting in one free memory location of the eight memories for regional operating settings. If there is no free memory location, the oldest regional operating setting should be replaced by the new, accepted one.

No means other than defined herein should be allowed to clear any or all of the stored regional operating settings. In particular, it should not be possible to solely clear any or all of the stored regional operating settings by a manual input or by an input via the Presentation Interface without inputting a new regional operating setting.

4.1.9 Conditions for changing both AIS operational frequency channels

When a competent authority needs to change both AIS operating frequency channels within a region, there should be a minimum time period of 9 min after the first AIS operating frequency channel is changed before the second AIS operating frequency channel is changed. This will ensure a safe frequency transition.

4.2 Distribution of transmission packets

4.2.1 The user directory

The user directory is internal to the AIS, and it is used to facilitate slot selection and synchronization. It is also used to select the proper channel for the transmission of an addressed message.

4.2.2 Routing of transmission packets

The following tasks are fulfilled with regard to packet routing:

- Position reports should be distributed to the presentation interface.
- Own position should be reported to the presentation interface and it should also be transmitted over the VDL.
- A priority is assigned to messages if message queuing is necessary.
- Received GNSS corrections are output to the presentation interface.

4.2.3 Management of priority assignments for messages

There are 4 (four) levels of message priority, namely:

Priority 1 (highest priority): Critical link management messages including position report messages in order to ensure the viability of the link.

Priority 2 (highest service priority): Safety related messages. These messages should be transmitted with a minimum of delay.

Priority 3: Assignment, interrogation and responses to interrogation messages.

Priority 4 (lowest priority): All other messages.

For details, refer to Table 43, Annex 8.

The above priorities are assigned to the relevant type of messages, thereby providing a mechanism for sequencing specific messages in order of priority. The messages are serviced in order of priority. This applies to both messages received and messages to be transmitted. Messages with the same priority are dealt with in an FIFO order.

4.3 Changing reporting interval

The parameter, R_r , is defined in § 3.3.4.4.2 (Table 16) and should be directly related to reporting interval as defined in Tables 1 and Table 2 in Annex 1. R_r should be determined by the network layer, either autonomously or as a result of an assignment by Message 16 (see § 3.3.6) or 23 (see § 3.21, Annex 8). The default value of the R_r should be as stated in Table 1 and Table 2 of Annex 1. A mobile station should, when accessing the VDL for the first time, use the default value (refer to § 3.3.5.2). When a mobile station uses an R_r of less than one report per frame, it should use ITDMA for scheduling. Otherwise SOTDMA should be used.

4.3.1 Autonomously changed R_r (continuous and autonomous mode)

This paragraph, including subparagraphs, applies to Class A and Class B “SO” shipborne mobile equipment.

4.3.1.1 Speed

The Rr should be affected by changes of speed as described in this paragraph. Speed should be determined by speed over ground (SOG). When an increase in speed results in a higher Rr (see Tables 1 and 2 in Annex 1) than the currently used Rr, the station should increase the Rr using the algorithm described in § 3.3.5. When a station has maintained a speed, which should result in an Rr lower than the currently used Rr, the station should reduce Rr when this state has persisted for three (3) min.

If speed information is lost during normal operation, the reporting schedule should revert to the default reporting interval, unless a new transmission schedule is ordered by assigned mode command.

4.3.1.2 Changing course (applicable to Class A shipborne mobile equipment, only)

When a ship changes course, a shorter reporting interval should be required according to Table 1, Annex 1. Rr should be affected by changing course as described in this paragraph.

A change of course should be determined by calculating the mean value of the heading information (HDG) for the last 30 s and comparing the result with the present heading. When HDG is unavailable, the Rr should not be affected.

If the difference exceeds 5°, a higher Rr should be applied in accordance with Table 1, Annex 1. The higher Rr should be maintained by using ITDMA to complement SOTDMA scheduled transmissions in order to derive the desired Rr. When 5° is exceeded, the reporting interval should be decreased beginning with a broadcast within the next 150 slots (see § 3.3.4.2.1) using either a scheduled SOTDMA slot, or a RATDMA access slot (see § 3.3.5.5).

The increased Rr should be maintained until the difference between the mean value of heading and present heading has been less than 5° for more than 20 s.

If heading information is lost during normal operation, the reporting schedule should revert to the default reporting interval, unless a new transmission schedule is ordered by assigned mode command.

When in assigned mode and a course change is requiring a shorter reporting interval than the interval that has been assigned, the station should:

- continue assigned mode (transmitting Message 2), and
- keep the assigned mode schedule (slot or interval assigned), and
- add two additional Messages 3 between the basic Message 2, like in autonomous mode².

4.3.1.3 Navigational status (applicable to Class A shipborne mobile equipment, only)

Rr should be affected by navigational status (refer to Messages 1, 2 and 3) as described in this paragraph when the vessel is not moving faster than 3 knots (to be determined by using SOG). When the vessel is at anchor, moored, not under command or aground, which is indicated by the navigational status, and not moving faster than 3 knots, Message 3 should be used with an Rr of 3 min. The navigational status should be set by the user via the appropriate user interface. The transmission of Message 3 should be interleaved three (3) min after Message 5. The Rr should be maintained until the navigational status is changed or SOG increases to more than 3 knots.

² Depending on the basic reporting interval, this may temporarily result in a shorter reporting interval as required by speed and course change, but this seems to be acceptable.

4.3.2 Assigned Rr

A competent authority may assign an Rr to any mobile station by transmitting assignment Message 16 from a base station. Except for the Class A shipborne mobile AIS station, an assigned Rr should have precedence over all other reasons for changing Rr. If the autonomous mode requires a higher Rr than that directed by Message 16, the Class A shipborne mobile AIS station should use the autonomous mode.

4.4 Data link congestion resolution

When the data link is loaded to such a level that the transmission of safety information is jeopardized, one of the following methods should be used to resolve the congestion.

4.4.1 Intentional slot reuse by the own station

A station should reuse time slots only in accordance with this paragraph and only when own position is available.

When selecting new slots for transmission, the station should select from its candidate slot set (see § 3.3.1.2) within the desired SI. When the candidate slot set has less than 4 slots, the station should intentionally reuse available slots, in order to make the candidate slot set equal to 4 slots. Slots may not be intentionally reused from stations that indicate no position available. This may result in fewer than 4 candidate slots. The intentionally reused slots should be taken from the most distant station(s) within the SI. Slots allocated or used by base stations should not be used unless the base station is located over 120 NM from the own station. When a distant station has been subject to intentional slot reuse, that station should be excluded from further intentional slot reuse during a time period equal to one frame.

Slot reuse provides candidate slots for random selection. This process attempts to increase the candidate slot set to a maximum of four. When the candidate slot set has reached four, the candidate slot selection process is complete. If four slots have not been identified after all the rules have been applied, this process may report less than four slots. Candidate slots for reuse should be selected using the following priorities beginning with Rule 1 (also see the Slot selection rules flow diagram – Fig. 22).

Add to the Free slot set (if any) all slots that are:

Rule 1: Free (see § 3.1.6) on selection channel and Available⁽¹⁾ (see § 3.1.6) on the other channel.

Rule 2: Available⁽¹⁾ on selection channel and Free on the other channel.

Rule 3: Available⁽¹⁾ on both channels.

Rule 4: Free on selection channel and Unavailable⁽²⁾ on the other channel.

Rule 5: Available⁽¹⁾ on selection channel and Unavailable⁽²⁾ on the other channel.

⁽¹⁾ Available – Mobile Station (SOTDMA or ITDMA), or Base Station reserved slot (FATDMA or Message 4) beyond 120 NM.

⁽²⁾ Unavailable – Base Station reserved slot (FATDMA or Message 4) within 120 NM, or a Mobile Station reporting without position information.

Figure 21 is an example applying these rules.

FIGURE 21

		SI											
		1	2	3	4	5	6	7	8	9	10	11	12
Channel A		F	F	F	F	T	T	D	F	X	X	X	B
Channel B		F	T	D	E	F	T	F	B	F	I	F	F

1371-21

It is intended to reuse one slot within the SI of frequency channel A. The current status of the use of the slots within the SI on both frequency channels A and B is given as follows:

- F: Free
 I: Internally allocated (allocated by own station, not in use)
 E: Externally allocated (allocated by another station near own station)
 B: Allocated by a base station within 120 NM of own station
 T: Another station under way that has not been received for 3 min or more
 D: Allocated by the most distant station(s)
 X: Should not be used.

The slot for intentional slot reuse should then be selected by the following priority (indicated by the number of the slot combination as given in Fig. 21):

- Highest Selection Priority: No. 1
 No. 2
 No. 5
 No. 6
 No. 3
 No. 4
 No. 7
 Lowest Selection Priority No. 8

Combinations 9, 10, 11 and 12 should not be used.

Rationale for not using slot combinations:

- No. 9 Adjacent slot rule
 No. 10 Opposite channel rule
 No. 11 Adjacent slot rule
 No. 12 Base station rule.

FIGURE 22
Slot selection rules flow diagram

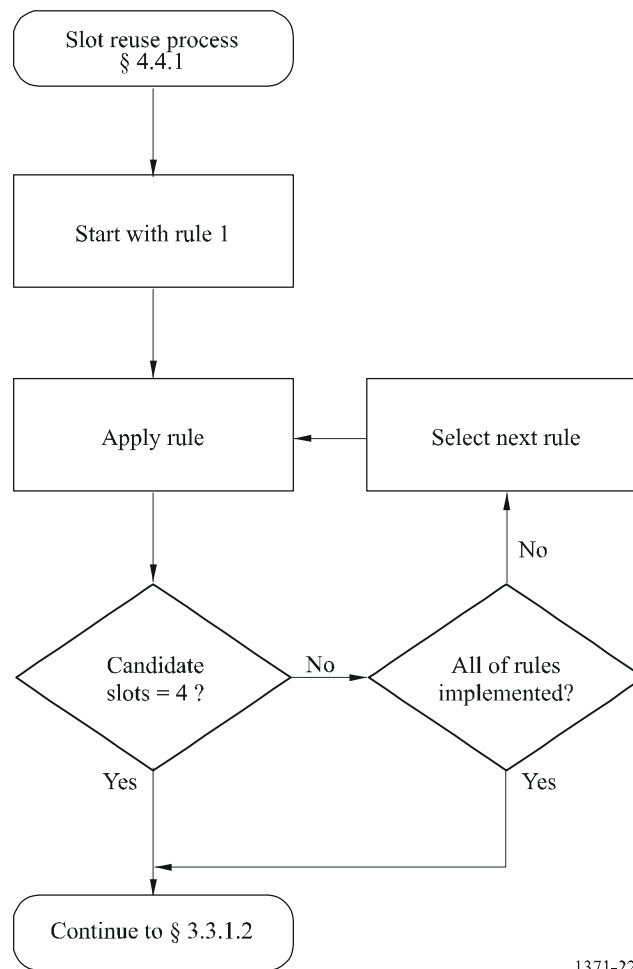

1371-22

4.4.2 Use of assignment for congestion resolution

A base station may assign R_r to all mobile stations except Class A shipborne mobile AIS stations to resolve congestion and can thus protect the viability of the VDL. To resolve congestion for Class A shipborne mobile AIS stations, the base station may use slot assignments to redirect slots used by the Class A shipborne mobile AIS station to FATDMA reserved slots.

4.5 Base station operation

A Base station accomplishes the following tasks:

- provides synchronization for stations not directly synchronized: base station reports (Message 4) with the default reporting interval;
- provides transmission slot assignments (see § 3.3.6.2 and § 4.4.2);
- provides assignment of R_r to mobile station(s) (see § 3.3.6.1 and § 4.3.2);
- transmits channel management messages;
- optionally provides GNSS corrections via the VDL by Message 17.

4.6 Repeater operation

Where it is necessary to provide extended coverage, repeater functionality should be considered. The extended AIS environment may contain one or more repeaters.

In order to implement this function efficiently and safely, the competent authority should perform a comprehensive analysis of the required coverage area and user traffic load, applying the relevant engineering standards and requirements.

A repeater may operate in the following modes:

- Duplex repeater mode.
- Simplex repeater mode.

4.6.1 Repeat indicator

4.6.1.1 Mobile station use of repeat indicator

When mobile station is transmitting a message, it should always set the repeat indicator to default = 0.

4.6.1.2 Base station/simplex repeater station use of repeat indicator

The repeat indicator should be increased whenever the transmitted message is a repeat of a message already transmitted from another station.

When a base station is used to transmit messages on behalf of another entity (authority, AtoN, or a virtual or synthetic AtoN), that uses an MMSI other than the base station's own MMSI, the repeat indicator of the transmitted message should be set to a non-zero value (as appropriate) in order to indicate that the message is a retransmission. The message can be communicated to the base station for retransmission using the VDL, network connection, station configuration, or other methods.

4.6.1.2.1 Number of repeats

The number of repeats should be a repeater station configurable function, implemented by the competent authority.

The number of repeats should be set to either 1 or 2, indicating the number of further repeats required.

All repeaters within coverage of one another should be set to the same number of repeats, in order to ensure that "Binary acknowledgement" Message 7 and "Safety related acknowledgement" Message 13 are delivered to the originating station.

Each time a received message is processed by the repeater station, the repeat indicator value should be incremented by one (+1) before retransmitting the message. If the processed repeat indicator equals 3, the relevant message should not be retransmitted.

4.6.2 Duplex repeater mode

This is a real-time application – the same time slot is used for retransmission on the paired frequency.

The received message requires no additional processing before being retransmitted.

Repeat indicator is not relevant when being used in duplex repeater mode.

A duplex channel is required, which comprises a pair of frequencies, as described in Recommendation ITU-R M.1084.

4.6.3 Simplex repeater mode

This is a Base station, which is specifically configured, in order to perform a repeater function.

This is not a real-time application – additional use of slots is required (store-and-forward).

Retransmission of messages should be performed as soon as possible after receiving the relevant messages which are required to be retransmitted.

Retransmission (repeat) should be performed on the same channel in which the original message was received by the repeater station.

4.6.3.1 Received messages

A received message requires additional processing before being retransmitted. The following processing is required:

- Select additional slot(s), required for re-transmitting message(s).
- Apply the same access scheme as in original slot use (received message).
- The communication state of relevant received messages should be changed, and is subject to parameters required by the slot(s) selected for retransmission by the repeater station.

4.6.3.2 Additional processing functionality

Filtering should be a function that is configurable by the repeater station, implemented by the competent authority.

Filtering of retransmissions should be applied, considering the following as parameters:

- Message types.
- Coverage area.
- Required message reporting interval (possibly increasing the reporting interval).

4.6.3.3 Synchronization and slot selection

Intentional slot reuse (see § 4.4.1) should be performed when required. In order to assist in slot selection, measurement of received signal strength by the repeater station should be considered. The received signal strength indicator will indicate when two or more stations are transmitting in the same slot at approximately the same distance from the repeater station. A high level of received signal strength will indicate that the transmitting stations are close to the repeater, and a low level of received signal strength will indicate that the transmitting stations are farther away.

Congestion resolution on the VDL may be applied (see § 4.4.2).

4.7 Handling of errors related to packet sequencing and groups of packets

It should be possible to group transmission packets, which are addressed to another station (refer to addressed binary and addressed safety related messages) based on sequence number. Addressed packets should be assigned a sequence number by the transmitting station. The sequence number of a received packet should be forwarded together with the packet to the transport layer. Also, when errors related to packet sequencing and groups of packets are detected (see § 3.2.3), they should be handled by the transport layer as described in § 5.3.1.

5 Transport layer

The transport layer is responsible for:

- converting data into transmission packets of correct size;
- sequencing of data packets;
- interfacing protocol to upper layers.

The interface between the transport layer and higher layers should be performed by the presentation interface.

5.1 Definition of transmission packet

A transmission packet is an internal representation of some information which can ultimately be communicated to external systems. The transmission packet is dimensioned so that it conforms to the rules of data transfer.

5.2 Conversion of data into transmission packets

5.2.1 Conversion to transmission packets

The transport layer should convert data, received from the presentation interface, into transmission packets. If the length of the data requires a transmission that exceeds five (5) slots (see Table 21 for guidance) or, for a mobile AIS station, if the total number of RATDMA transmissions of Messages 6, 8, 12 and 14 in this frame exceeds 20 slots the AIS should not transmit the data, and it should respond with a negative acknowledgement to the presentation interface.

Table 21 is based on the assumption that the theoretical maximum of stuffing bits will be needed. A mechanism may be applied, which determines, prior to transmission, what the actually required bit stuffing will be with reference to § 3.2.2.1, depending on the actual content of the input for transmission from the presentation interface. If this mechanism determines that less stuffing bits than indicated in Table 21 would be needed, more data bits than indicated in Table 21 may be transmitted, applying the actually required number of stuffing bits. However, the total number of slots required for this transmission should not be increased by this optimization.

Taking into account that safety related and binary messages should be used, it is of importance that the variable messages are set on byte boundaries. In order to ensure that the required bit stuffing for the variable length messages is provided for in the worst-case condition, with reference to the packet format (see. § 3.2.2.2) the following parameters should be used as a guideline:

TABLE 21

Number of slots	Maximum data bits	Stuffing bits	Total buffer bits
1	136	36	56
2	360	68	88
3	584	100	120
4	808	132	152
5	1 032	164	184

5.3 Transmission packets

5.3.1 Addressed Messages 6 and 12

Addressed messages should have a destination user ID. The source station should anticipate an acknowledgement message (Message 7 or Message 13). If an acknowledgement is not received the station should retry the transmission. The station should wait 4 s before attempting retries. When a transmission is retried, the retransmit flag should be set to retransmitted. The number of retries should be 3, but it could be configurable between 0 and 3 retries by an external application via the presentation interface. When set to a different value by an external application, the number of retries should default to 3 retries after 8 min. The overall result of the data transfer should be forwarded to above layers. The acknowledgement should be between transport layers in two stations.

Each data transfer packet on the presentation interface should have a unique packet identifier consisting of the message type (binary or safety related messages), the source-ID, the destination-ID, and a sequence number.

The sequence number should be assigned in the appropriate presentation interface message which is input to the station.

The destination station should return the same sequence number in its acknowledgement message on the presentation interface.

The source station should not reuse a sequence number until it has been acknowledged or time-out has occurred.

The acknowledgement should be put first in the data transfer queue both on the presentation interface and on the VDL.

These acknowledgements are applicable only to the VDL. Other means must be employed for acknowledging applications.

See Fig. 23 and Annex 6.

FIGURE 23

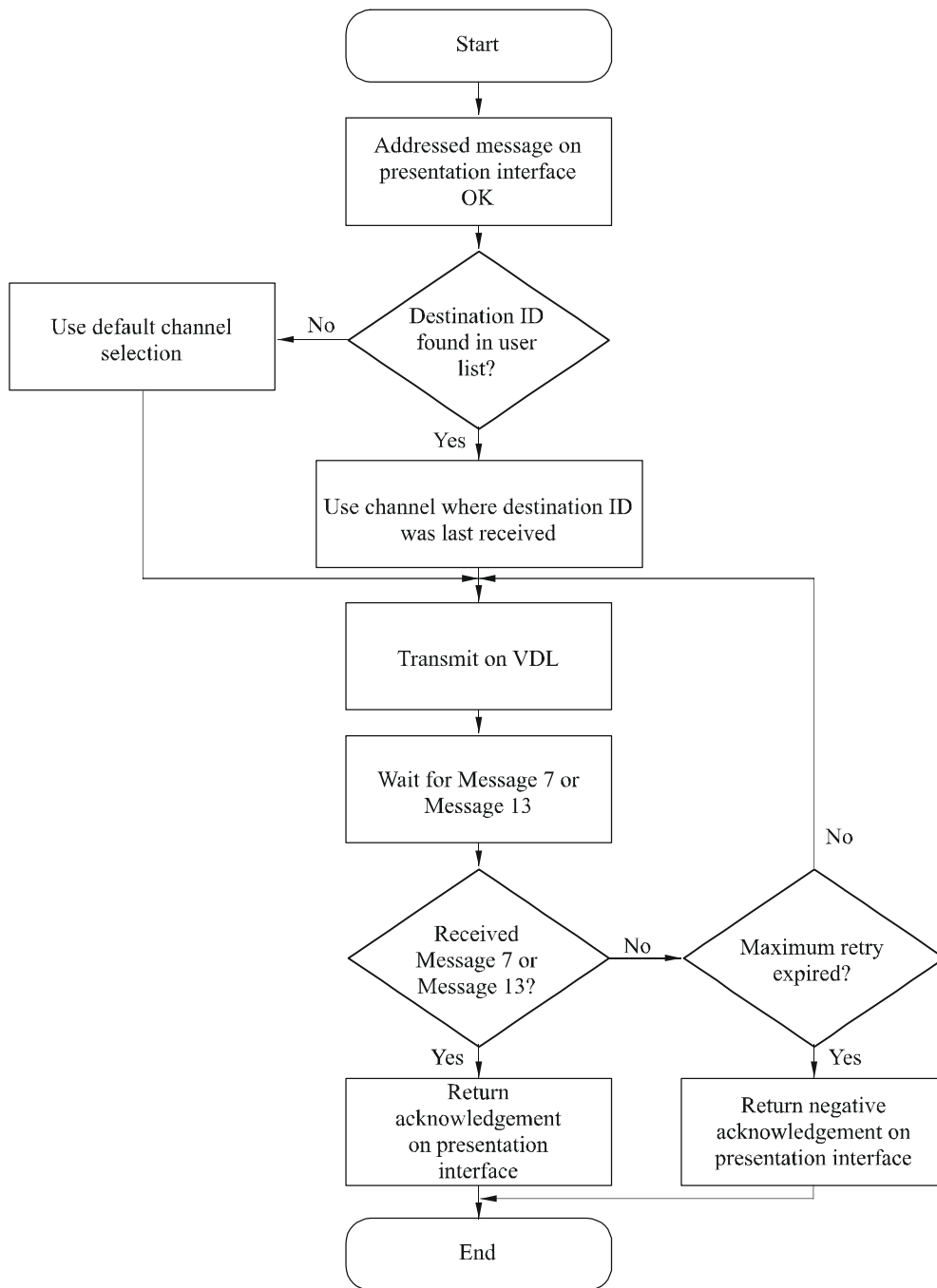

1371-23

5.3.2 Broadcast messages

A broadcast message lacks a destination identifier ID. Therefore receiving stations should not acknowledge a broadcast message.

5.3.3 Conversion to presentation interface messages

Each received transmission packet should be converted to a corresponding presentation interface message and presented in the order they were received regardless of message category. Applications utilizing the presentation interface should be responsible for their own sequencing numbering scheme, as required. For a mobile station, addressed messages should not be output to the presentation interface, if destination User ID (destination MMSI) is different to the ID of own station (own MMSI).

5.4 Presentation interface protocol

Data, which is to be transmitted by the AIS device, should be input via the presentation interface; data, which is received by the AIS device, should be output through the presentation interface. The formats and protocol used for this data stream are defined by IEC 61162 series.

Annex 3

AIS channel management by digital selective calling messages³

1 General

1.1 Mobile AIS stations (required for Class A and optional for other Classes) with the capability to receive and process DSC messages should only act in response to DSC messages for the purpose of AIS channel management. All other DSC messages should be disregarded. See § 1.2 for details of the applicable DSC expansion symbols. Class A AIS should contain a dedicated DSC receiver that is permanently tuned to channel 70.

1.2 DSC-equipped shore stations may transmit VTS area geographic coordinates calls only or calls specifically addressed to individual stations on channel 70 to specify regional boundaries and regional frequency channels and transmitter power level to be used by the AIS in those specified regions. The AIS device should be capable of processing the expansion symbols Nos. 00, 01, 09, 10, 11, 12, and 13 of Table 5 of Recommendation ITU-R M.825 by performing operations in accordance with § 4.1, Annex 2 with the regional frequencies and regional boundaries specified by these calls. Calls addressed to individual stations that do not contain expansion symbols Nos. 12 and 13 should be used to command these stations to use the specified channels until further commands are transmitted to these stations. Primary and secondary regional channels (Recommendation ITU-R M.825, Table 5) correspond to Table 72, Annex 8 (Message 22) channel A and channel B, respectively. The only values used by expansion symbol Nos. 01 should be 01 and 12, meaning 1 W or 12.5 W. This applies to TDMA transmissions.

Expansion symbol No. 00 does not affect TDMA channels.

1.3 The shore station should ensure that the total DSC traffic should be limited to 0.075 E in accordance with Recommendation ITU-R M.822.

2 Scheduling

Shore stations that transmit VTS area geographic coordinates calls only to designate AIS regions and frequency channels should schedule their transmissions such that ships transiting these regions will receive sufficient notice to be able to perform the operations in § 4.1.1, Annex 2 to § 4.1.5, Annex 2. A transmission interval of 15 min is recommended, and each transmission should be made twice, with a time separation of 500 ms between the two transmissions, in order to ensure that reception by AIS transponders is accomplished.

³ See Recommendations ITU-R M.493, ITU-R M.541, ITU-R M.825 and ITU-R M.1084, Annex 4.

3 Regional channel designation

3.1 For designation of regional AIS frequency channels, expansion symbols Nos. 09, 10 and 11 should be used in accordance with Table 5 of Recommendation ITU-R M.825. Each of these expansion symbols should be followed by two DSC symbols (4 digits) which specify the AIS regional channel(s), as defined by Recommendation ITU-R M.1084, Annex 4. This allows for simplex 25 kHz channels for regional options, subject to the provisions of RR Appendix 18. Expansion symbol No. 09 should designate the primary regional channel, and expansion symbol Nos. 10 or 11 should be used to designate the secondary regional channel. The RF interference environment flag does not apply to AIS. It should be set to zero. Designation of regional channels should also consider § 4.1.5.1, Annex 2 and § 4.1.9, Annex 2.

3.2 When single-channel operation is required, expansion symbol No. 09 should be used, only. For two-channel operation, either expansion symbol No. 10 should be used to indicate that the secondary channel is to operate in both transmit and receive modes, or expansion symbol No. 11 should be used to indicate that the secondary channel is to operate only in receive mode.

4 Regional area designation

For designation of regional areas for utilizing AIS frequency channels, expansion symbols Nos. 12 and 13 should be in accordance with Table 5 of Recommendation ITU-R M.825. Expansion symbol No. 12 should be followed by the geographical coordinate address of the north-eastern corner of the Mercator projection rectangle to the nearest tenth of a minute. Expansion symbol No. 13 should be followed by the geographical coordinate address of the south-western corner of the Mercator projection rectangle to the nearest tenth of a minute. When using DSC for regional area designation it should be assumed that the transitional zone size has the default value (5 nm). For calls addressed to individual stations, expansion symbols Nos. 12 and 13 may be omitted (see § 1.2 of this annex).

Annex 4

Long-range applications

1 General

Long-range applications should be by interface to other equipment and by broadcast.

2 Long-range applications by interface to other equipment

Class A shipborne mobile equipment should provide a two-way interface for equipment which provides for long-range communications. This interface should comply with IEC 61162 series.

Applications for long-range communications should consider that:

- The long-range application of AIS must operate in parallel with the VDL. Long-range operation will not be continuous. The system will not be designed for constructing and maintaining real-time traffic images for a large area. Position updates will be in the order of 2-4 times per hour (maximum). Some applications require an update of just twice a day. It can be stated that long-range application forms hardly any workload to the communication system or the transponder and will not interfere with the normal VDL operation.

- The long-range operational mode will be on interrogation basis only for geographical areas. Base stations shall interrogate AIS systems, initially by geographical area, followed by addressed interrogation. Only AIS information will be included in the reply; e.g. position and static and voyage-related data.
- The communication system for long-range AIS is not defined in this Recommendation.

Example configuration:

Operation with Inmarsat-C.

The general set-up of the long-range configuration is in Fig. 24.

FIGURE 24

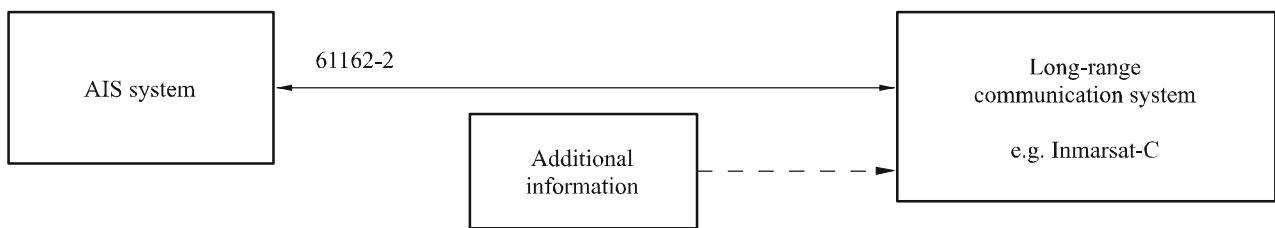

1371-24

Because of the lack of IEC 61162-2 interfaces on long-range communication systems, the configuration shown in Fig. 25 can be used as an interim solution.

FIGURE 25

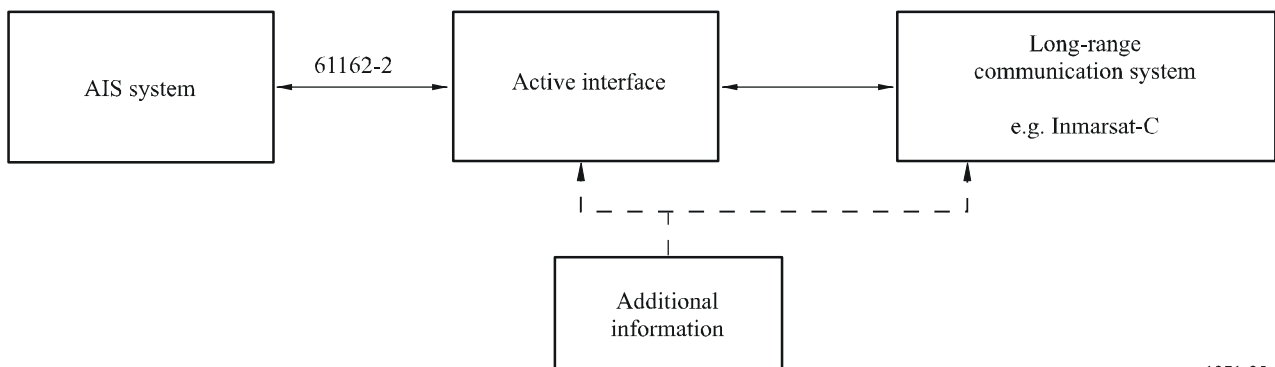

1371-25

3 Long-range applications by broadcast

Long-range AIS receiving systems may receive long-range AIS broadcast messages, provided these messages are appropriately structured and transmitted to suit the receiving systems.

3.1 Packet bit structure for the AIS long-range broadcast message

Long-range AIS receiving systems require suitable buffering in order to preserve the integrity of the AIS message in the AIS slot boundaries. Table 1 shows a modified packet bit structure that is designed to support reception of AIS messages by satellites with orbital altitudes up to 1 000 km.

TABLE 1

Modified packet bit structure for long-range AIS message reception

Slot composition	Bits	Notes
Ramp up	8	Standard
Training sequence	24	Standard
Start flag	8	Standard
Data field	96	Data field is 168 bits for other single-slot AIS messages. This field is shortened by 72 bits to support the long-range receiving system buffer
CRC	16	Standard
End flag	8	Standard
Long-range AIS receiving system buffer	96	Bit stuffing = 4 bits Synch jitter (mobile station) = 3 bits Synch jitter (mobile/satellite) = 1 bit Propagation time delay difference = 87 bits Spare = 1 bit
Total	256	Standard (NOTE – Only 160 bits are used in the 17 ms transmission)

3.2 Long-range AIS broadcast message

The long-range AIS broadcast message – Message 27 – data field is shown in Annex 8 Table 81.

3.3 Transmission method for the long-range AIS broadcast message

The long-range AIS broadcast message should be transmitted by the AIS Class A stations at the current power setting using the transmission interval, access scheme, AIS shore station qualifier and two separate designated long-range channels (not AIS 1 and AIS 2) specified below. The AIS Class A should perform the long-range AIS broadcast as a transmit-only function.

3.3.1 Transmission interval

The nominal transmission interval for the long-range AIS broadcast message should be 3 min.

3.3.2 Access scheme

The access scheme for transmitting the long-range AIS broadcast message should be RATDMA. The AIS should consider only the two frequencies in the AIS VDL for qualifying the candidate slots for the transmission of the long-range AIS message. The AIS VDL is comprised only of channel A (by default AIS 1) and channel B (by default AIS 2). The long-range AIS broadcast on the two separate designated long-range channels should not be considered part of the AIS VDL for the purpose of scheduling the RATDMA transmissions of the long-range AIS broadcast messages.

3.3.3 AIS shore station qualifier

Transmission of the long-range AIS broadcast message, when the AIS Class-A station is in the range of an AIS base station, should be left to the decision of the competent authority by Message 4. If the AIS Class A station does not receive a Message 4, it should revert to its nominal behaviour after 3 min.

3.3.4 Transmitting the long-range broadcast message

The long-range AIS broadcast message should be transmitted only on the two separate designated channels and not on the AIS channels (AIS 1, AIS 2 or regional channels). The transmissions should alternate between these two channels such that each channel is used once every 6 min.

Annex 5

Application specific messages

1 General

AIS messages where the data content is defined by the application are application specific messages. Examples of this are the binary Messages 6 and 8. The data content does not affect the operation of the AIS. AIS is a means for transferring the data content between stations. A functional message's data structure consists of an application identifier (AI) followed by the application data.

1.1 Binary messages

A binary message consist of three parts:

- Standard AIS framework (message ID, repeat indicator, source ID, and, for addressed binary messages, a destination ID)
- 16-bit application identifier (AI = DAC + FI), consisting of:
 - 10-bit designated area code (DAC) – based on the MID;
 - 6-bit function identifier (FI) – allows for 64 unique application specific messages.
- Data content (variable length up to a given maximum).

1.2 Definition of application identifiers

The application identifier uniquely identifies the message and its contents. The application identifier is a 16-bit number used to identify the meaning of the bits making up the data content. The use of application identifiers is defined in § 2.

The DAC is a 10-bit number. DAC assignments are:

- international (DAC = 1-9), maintained by international agreement for global use;
- regional (DAC > 10), maintained by the regional authorities affected;
- test (DAC = 0), used for test purposes.

It is recommended that DAC 2-9 be used to identify subsequent versions of international specific messages and that the administrator of application specific messages base the DAC selection on the maritime identification digit (MID) of the administrator's country or region. It is the intention that any application specific message can be utilized worldwide. The choice of the DAC does not limit the area where the message can be used.

The FI is a 6-bit number assigned to uniquely identify the data content structure within an application under a DAC assignment. Each DAC can support up to 64 applications.

- The definition of the technical characteristics, as defined in Annexes 2, 3 and 4, of any AIS station covers layers 1 to 4 of the OSI model, only (see § 1, Annex 2).
- The layers 5 (session layer), 6 (presentation layer) and 7 (application layer, that includes the human-machine-interface) should be in accordance with the definitions and guidelines given in this Annex in order to avoid application conflicts.

1.3 Definition of function messages

Each unique combination of application identifier (AI) and application data forms a functional message. The coding and decoding of the data content of a binary message is based on a table identified by the AI value. Tables identified by an International AI (IAI) value should be maintained and published by the international authority responsible for defining international function messages (IFM). Maintenance and publication of regional AI tables (RAI), defining regional function messages (RFM) should be the responsibility of national or regional authorities.

Table 23 identifies up to ten IFM designed to provide support for any implementation of broadcast and addressed binary messages (system applications). These are defined and maintained by ITU.

2 Binary data structure

This chapter provides general guidance for developing the structure of the data content for broadcast and addressed binary messages.

2.1 Application identifier

Addressed and broadcast binary messages should contain a 16-bit application identifier, structured as follows:

TABLE 22

Bit	Description
15-6	Designated area code (DAC). This code is based on the maritime identification digits (MID). Exceptions are 0 (test) and 1 (international). Although the length is 10 bits, the DAC codes equal to or above 1 000 are reserved for future use
5-0	Function identifier. The meaning should be determined by the authority which is responsible for the area given in the designated area code

Whereas the application identifier allows for regional applications, the application identifier should have the following special values for international compatibility.

2.1.1 Test application identifier

The test application identifier (DAC = 0) with any function identifier (0 to 63) should be used for testing purposes. The function identifier is arbitrary.

2.1.2 International application identifier

The international application identifier (DAC = 1) should be used for international applications of global relevance. Specific international applications are identified by a unique function identifier (see Table 23).

TABLE 23

Application identifier (decimal)		Application identifier (binary)		Description
DAC	Function identifier	DAC	Function identifier	
001	00	0000 0000 01	00 0000	IFM 0 = Text telegram 6-bit ASCII (§ 5.1)
001	01	0000 0000 01	00 0001	Discontinued
001	02	0000 0000 01	00 0010	IFM 2 = Interrogation on specific IFM (§ 5.2)
001	03	0000 0000 01	00 0011	IFM 3 = Capability interrogation (§ 5.3)
001	04	0000 0000 01	00 0100	IFM 4 = Capability interrogation reply (§ 5.4)
001	05	0000 0000 01	00 0101	IFM 5 = Application acknowledgement to an addressed binary message (§ 5.5)
001	06 to 09	0000 0000 01	–	Reserved for future system applications
001	10 to 63	0000 0000 01	–	Reserved for international operational applications

NOTE 1 – The DAC codes 1000 to 1023 are reserved for future use.

3 Guidelines for creating functional messages

Slot use by functional messages should take into account the system level impact on the VHF data link loading.

3.1 International functional messages

The following should be considered when creating international functional messages:

- published international functional messages (see IMO and ITU documents);
- legacy and compatibility issues with current, superseded, or obsolete message structures;
- period of time needed to formally introduce a new functionality;
- each functional message should have a unique identifier (AI);
- limited number of available international functional identifiers.

3.2 Regional functional messages

The following should be considered when creating regional functional messages:

- published regional and international functional messages;
- legacy and compatibility issues with current, superseded or obsolete message structures (e.g. 3-bit FI version indicator);
- period of time needed and cost to formally introduce a new functionality;
- each functional message should have a unique identifier (AI);
- limited number of functional identifiers allocated for local, regional, national, or multinational use;
- requirements for encrypted messages.

4 Guidelines for drafting functional messages

When developing functional messages (FM), the following should be considered:

- a message for test and evaluation purposes to ensure integrity in an operational system;
- rules given in § 3.3.7, Annex 2 (Message structure), and § 3, Annex 8 (Message descriptions);
- values for not available, normal, or malfunctioning should be defined for every data field, as appropriate;
- default values should be defined for each data field.

When position information is included, in addition to latitude and longitude, and if applicable, it should comprise data fields in the following order (see AIS Messages 1 and 5):

- position accuracy;
- longitude;
- latitude;
- precision;
- type of electronic position fixing device;
- time stamp.

When transmitting time and/or date information, other than time stamp for position information, this information should be as defined as follows (see AIS Message 4):

- UTC year: 1-9999; 0 = UTC year not available = default (14 bits)
- UTC month: 1-12; 0 = UTC month not available = default (4 bits)
- UTC day: 1-31; 0 = UTC day not available = default (5 bits)
- UTC hour: 0-23; 24 = UTC hour not available = default (5 bits)
- UTC minute: 0-59; 60 = UTC minute not available = default (6 bits)
- UTC second: 0-59; 60 = UTC second not available = default (6 bits).

When transmitting information on direction of movement, this should be defined as direction of movement over ground (see AIS Message 1).

All data fields of the FMs should observe byte boundaries. If needed to align with byte boundaries, spares should be inserted.

Applications should minimize slot use, taking into account buffering and bit-stuffing, see Annex 2 at the appropriate definition of the binary message.

5 Definitions of system related international function messages

5.1 IFM 0: Text using 6-bit ASCII

IFM 0 is used by applications that use AIS stations to transfer 6-bit ASCII text between applications. The text can be sent with binary Message 6 or 8. The parameter, “acknowledge required flag”, should be set to 0 when broadcast with Message 8.

When long text strings are sub-divided, an 11-bit “text sequence number” is used. The text sequence number is used by the originating application to sub-divide the text and by the recipient application to re-assemble the text. The text sequence numbers for each sub-division should be selected to be contiguous and always increasing (110, 111, 112, ...). If multiple texts are being transferred, the text sequence numbers should be chosen to associate correctly the sub-divided text with the correct text strings.

TABLE 24

IFM 0 using Message 6, addressed binary message

Parameter	Number of bits	Description
Message ID	6	Identifier for Message 6; always 6
Repeat indicator	2	Used by the repeater to indicate how many times a message has been repeated. See § 4.6.1, Annex 2; 0-3; 0 = default; 3 = do not repeat any more
Source ID	30	MMSI number of source station
Sequence number	2	0 – 3; see § 5.3.1, Annex 2
Destination ID	30	MMSI number of destination station
Retransmit flag	1	Retransmit flag should be set upon retransmission: 0 = no retransmission = default; 1 = retransmitted
Spare	1	Not used. Should be zero
DAC	10	International DAC = $1_{10} = 000000001_2$
FI	6	Function identifier = $0_{10} = 000000_2$
Acknowledge required flag	1	1 = reply is required, optional for addressed binary messages and not used for binary broadcast messages 0 = reply is not required, optional for an addressed binary message and required for binary broadcast messages
Text sequence number	11	Sequence number to be incremented by the application. All zeros indicates that sequence numbers are not being used
Text string	6-906	6-bit ASCII as defined in Table 44, Annex 8. When using this IFM, the number of slots used for transmission should be minimized taking into account Table 26. For Message 6 the maximum is 906
Spare bits	max 6	Not used for data and should be set to zero. The number of bits should be either 0, 2, 4, or 6 to maintain byte boundaries. NOTE 1 – When a 6-bit spare is needed to satisfy the 8-bit byte boundary rule, the 6-bit spare will be interpreted as a valid 6-bit character (all zeros is the “@” character). This is the case when the number of characters is : 1, 5, 9, 13,17, 21, 25, etc.
Total number of application data bits	112-1 008	For Message 6 the maximum is 920

TABLE 25

IFM 0 using Message 8, broadcast binary message

Parameter	Number of bits	Description
Message ID	6	Identifier for Message 8; always 8
Repeat indicator	2	Used by the repeater to indicate how many times a message has been repeated. See § 4.6.1, Annex 2; 0-3; 0 = default; 3 = do not repeat any more
Source ID	30	MMSI number of source station
Spare	2	Not used. Should be zero
DAC	10	International DAC = $1_{10} = 000000001_2$
FI	6	Function identifier = $0_{10} = 000000_2$
Acknowledge required flag	1	1 = reply is required, optional for addressed binary messages and not used for binary broadcast messages 0 = reply is not required, optional for an addressed binary message and required for binary broadcast messages
Text sequence number	11	Sequence number to be incremented by the application. All zeros indicates that sequence numbers are not being used
Text string	6-936	6-bit ASCII as defined in Table 44, Annex 8. When using this IFM, the number of slots used for transmission should be minimized taking into account Table 26. For Message 8 the maximum is 936
Spare bits	max 6	Not used for data and should be set to zero. The number of bits should be either 0, 2, 4, or 6 to maintain byte boundaries. NOTE 1 – When a 6-bit spare is needed to satisfy the 8-bit byte boundary rule, the 6-bit spare will be interpreted as a valid 6-bit character (all zeros is the “@” character). This is the case when the number of characters is: 1, 5, 9, 13,17, 21, 25, etc.
Total number of application data bits	80-1 008	

Table 26 gives an estimate of the maximum number of 6-bit-ASCII characters that can be in the application data field of the binary data parameter of Messages 6 and 8. The number of slots used will be affected by the bit stuffing process.

TABLE 26

Estimated number of slots	Maximum number of 6-bit ASCII characters based upon typical bit stuffing	
	Addressed binary Message 6	Broadcast binary Message 8
1	6	11
2	43	48
3	80	86
4	118	123
5	151	156

NOTE 1 – The 5-slot value accounts for the worst case bit stuffing condition.

5.2 IFM 2: Interrogation for a specific FM

IFM 2 should be used by an application to interrogate (using Message 6) another application for the specified functional message.

The application responding to this interrogation should use an addressed binary message to reply.

TABLE 27

Parameter	Number of bits	Description
Message ID	6	Identifier for Message 6; always 6
Repeat indicator	2	Used by the repeater to indicate how many times a message has been repeated. See § 4.6.1, Annex 2; 0-3; 0 = default; 3 = do not repeat any more
Source ID	30	MMSI number of source station
Sequence number	2	0-3; see § 5.3.1, Annex 2
Destination ID	30	MMSI number of destination station
Retransmit flag	1	Retransmit flag should be set upon retransmission: 0 = no retransmission = default; 1 = retransmitted
Spare	1	Not used. Should be zero
DAC	10	International DAC = $1_{10} = 000000001_2$
FI	6	Function identifier = $2_{10} = 000010_2$
Requested DAC code	10	IAI, RAI or test
Requested FI code	6	See appropriate FI reference document(s)
Spare bits	64	Not used, should be set to zero, reserved for future use
Total number of bits	168	The resulting Message 6 occupies 1 slot

5.3 IFM 3: Capability interrogation

IFM 3 should be used by an application to interrogate (using Message 6) another application for the availability of application identifiers for the specified DAC. The request is made separately for each DAC.

IFM 3 can only be used as the data content of an addressed binary message.

TABLE 28

Parameter	Number of bits	Description
Message ID	6	Identifier for Message 6; always 6
Repeat indicator	2	Used by the repeater to indicate how many times a message has been repeated. See § 4.6.1, Annex 2; 0-3; 0 = default; 3 = do not repeat any more
Source ID	30	MMSI number of source station
Sequence number	2	0-3; see § 5.3.1, Annex 2
Destination ID	30	MMSI number of destination station
Retransmit flag	1	Retransmit flag should be set upon retransmission: 0 = no retransmission = default; 1 = retransmitted

TABLE 28 (end)

Parameter	Number of bits	Description
Spare	1	Not used. Should be zero
DAC	10	International DAC = $1_{10} = 0000000001_2$
FI	6	Function identifier = $3_{10} = 000011_2$
Requested DAC code	10	IAI, RAI or test
Spare bits	70	Not used, should be set to zero, reserved for future use
Total number of bits	168	The resulting Message 6 occupies 1 slot

5.4 IFM 4: Capability reply

IFM 4 should be used by an application to reply (using Message 6) to a capability interrogation (IFM 3) function message. The reply contains the availability status of the application for each function identifier for the specified DAC.

The application should use an addressed binary message to reply to the interrogating application.

TABLE 29

Parameter	Number of bits	Description
Message ID	6	Identifier for Message 6; always 6
Repeat indicator	2	Used by the repeater to indicate how many times a message has been repeated. See § 4.6.1, Annex 2; 0-3; 0 = default; 3 = do not repeat any more
Source ID	30	MMSI number of source station
Sequence number	2	0-3; see § 5.3.1, Annex 2
Destination ID	30	MMSI number of destination station
Retransmit flag	1	Retransmit flag should be set upon retransmission: 0 = no retransmission = default; 1 = retransmitted
Spare	1	Not used. Should be zero
DAC	10	International DAC = $1_{10} = 0000000001_2$
FI	6	Function identifier = $4_{10} = 000100_2$
DAC code	10	IAI, RAI or test
FI availability	128	FI capability table, pair of two consecutive bits should be used for every FI, in the order FI 0, FI 1,FI 63. First bit of pair: 0 = FI not available (default) 1 = FI available. Second bit of the pair: reserved for future use; should be set to zero
Spare	126	Not used, should be set to zero, reserved for future use
Total number of bits	352	The resulting Message 6 occupies 2 slots

5.5 IFM 5: Application acknowledgement to an addressed binary message

When requested, IFM 5 should be used by an application to confirm the reception of an addressed binary message. An application should never acknowledge a binary broadcast message.

If the interrogating application does not receive an IFM 5, when requested, then the application should assume that addressed AIS unit does not have an application attached to its Presentation Interface (PI).

If there is any application at the AIS station, it should not respond if the “Acknowledge Required Flag” is set to 0.

TABLE 30

Parameter	Number of bits	Description
Message ID	6	Identifier for Message 6; always 6
Repeat indicator	2	Used by the repeater to indicate how many times a message has been repeated. See § 4.6.1, Annex 2; 0-3; 0 = default; 3 = do not repeat any more
Source ID	30	MMSI number of source station
Sequence number	2	0-3; see § 5.3.1, Annex 2
Destination ID	30	MMSI number of destination station
Retransmit flag	1	Retransmit flag should be set upon retransmission: 0 = no retransmission = default; 1 = retransmitted
Spare	1	Not used. Should be zero
DAC	10	International DAC = $1_{10} = 0000000001_2$
FI	6	Function identifier = $5_{10} = 000101_2$
DAC code of received FM	10	Recommended to be spare
FI code of received FM	6	
Text sequence number	11	Sequence number in the message being acknowledged as properly received 0 = default (no sequence number) 1-2 047 = sequence number of received FM
AI available	1	0 = received but AI not available 1 = AI available
AI response	3	0 = unable to respond 1 = reception acknowledged 2 = response to follow 3 = able to respond but currently inhibited 4-7 = spare for future use
Spare bits	49	Not used, should be set to zero, reserved for future use
Total number of bits	168	The resulting Message 6 occupies 1 slot

Annex 6

Sequencing of transmission packets

This annex describes the method by which information should be exchanged between stations' application layers (Application A and Application B) over the VDL through the PI.

The originating application assigns a sequence number to each transmission packet, using the addressed message. The sequence numbers can be 0, 1, 2 or 3. This number together with message type and destination gives the transmission a unique transaction identifier. This transaction identifier is communicated to the receiving application.

FIGURE 26

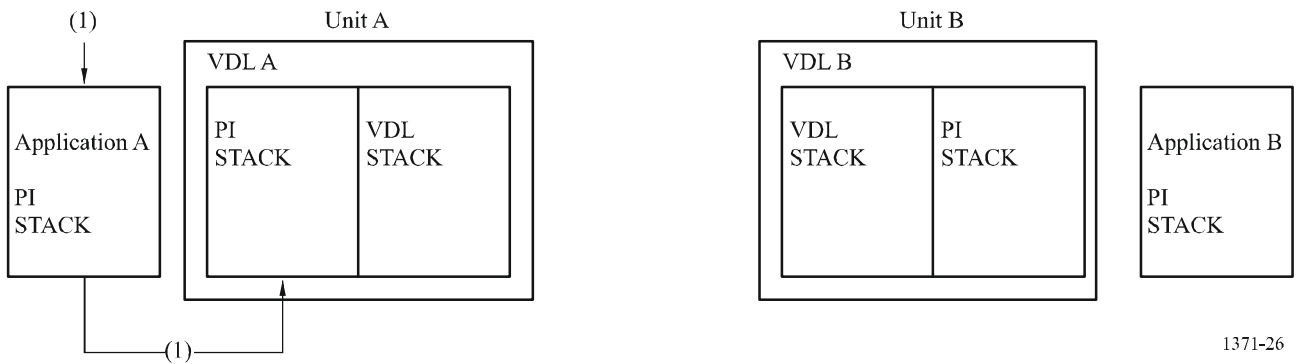

1371-26

Step 1: Application A delivers 4 addressed messages addressed to B with sequence numbers 0, 1, 2 and 3 via PI.

FIGURE 27

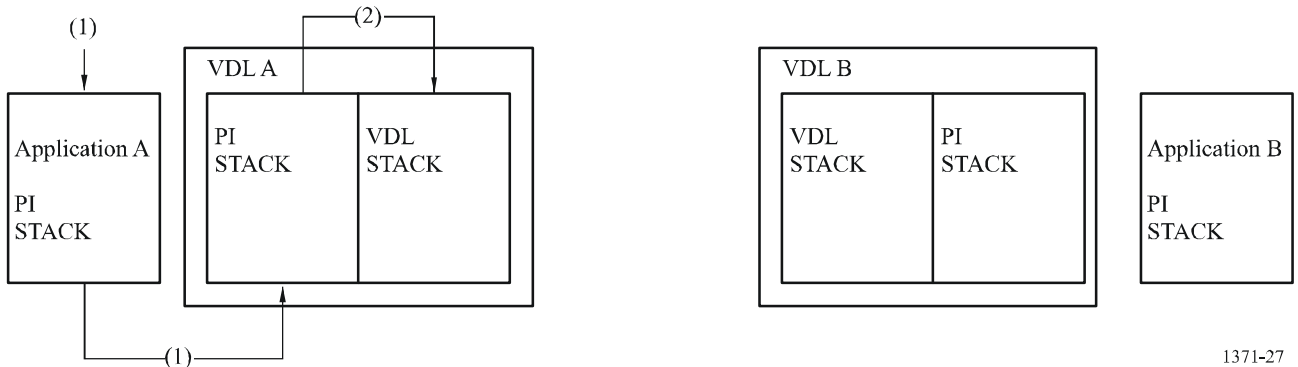

1371-27

Step 2: VDL A receives addressed messages and puts them in the transmit queue.

FIGURE 28

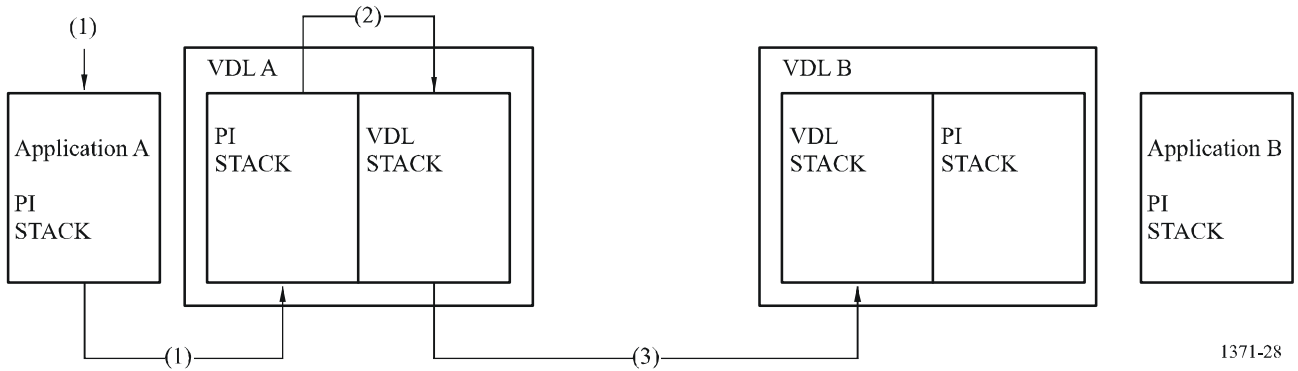

1371-28

Step 3: VDL A transmits the messages to VDL B, which only receives messages with sequence numbers 0 and 3.

FIGURE 29

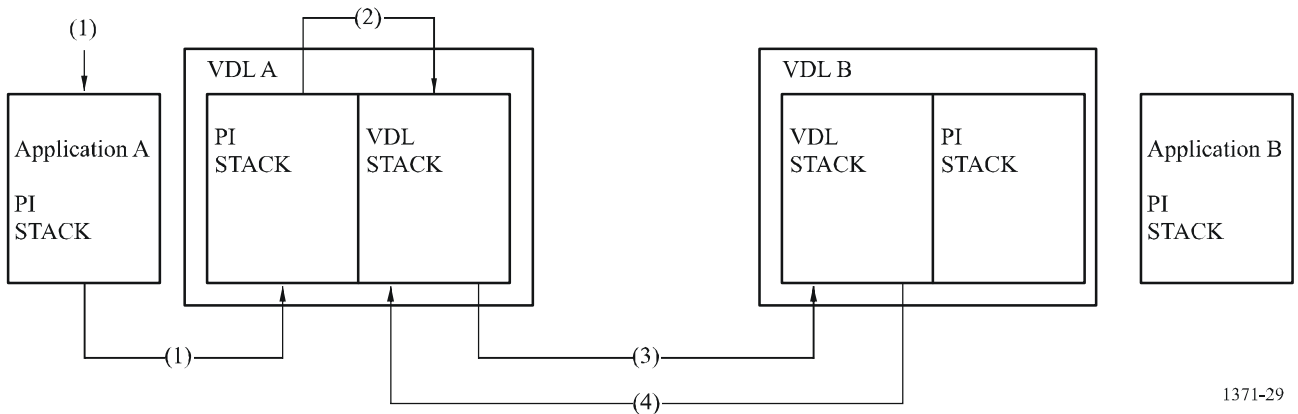

1371-29

Step 4: DL B returns VDL-ACK messages with sequence numbers 0 and 3 to VOL A.

FIGURE 30

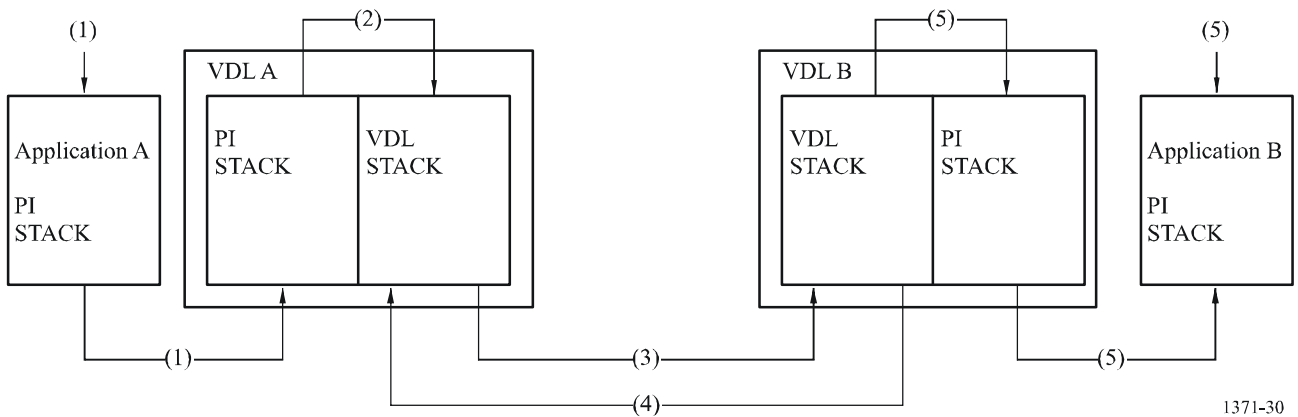

1371-30

Step 5: VDL B delivers addressed messages with sequence numbers 0 and 3 to Application B.

FIGURE 31

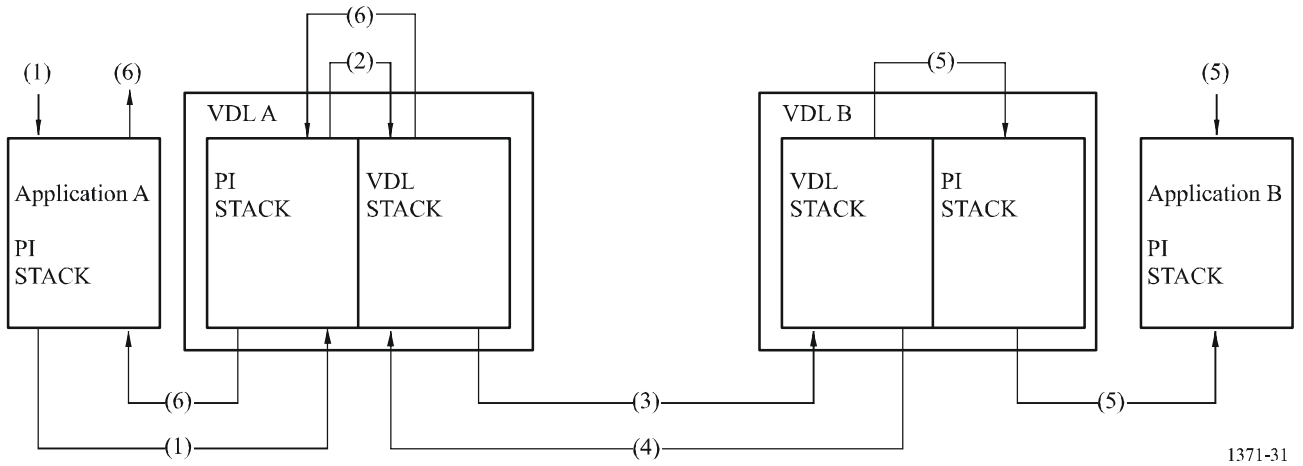

1371-31

Step 6: VDL A returns PI-ACK (OK) to Application A with sequence numbers 0 and 3.

FIGURE 32

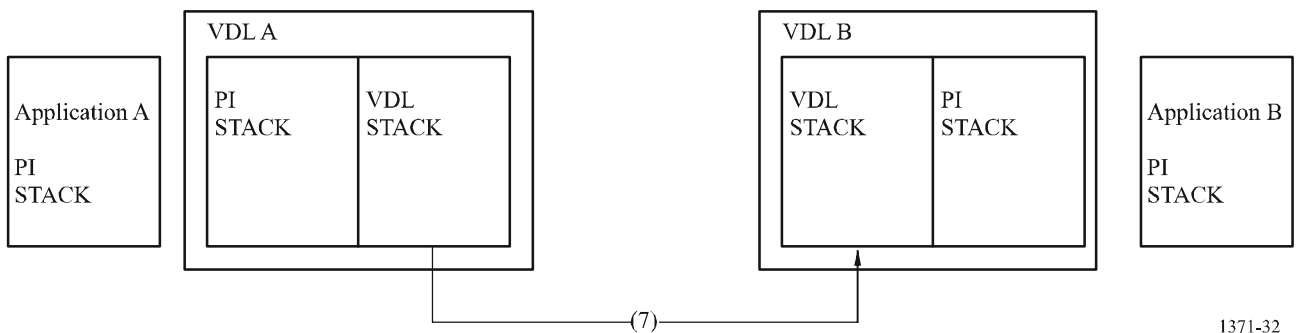

1371-32

Step 7: VDL A times out on sequence numbers 1 and 2 and retransmits the addressed messages to VDL B.

FIGURE 33

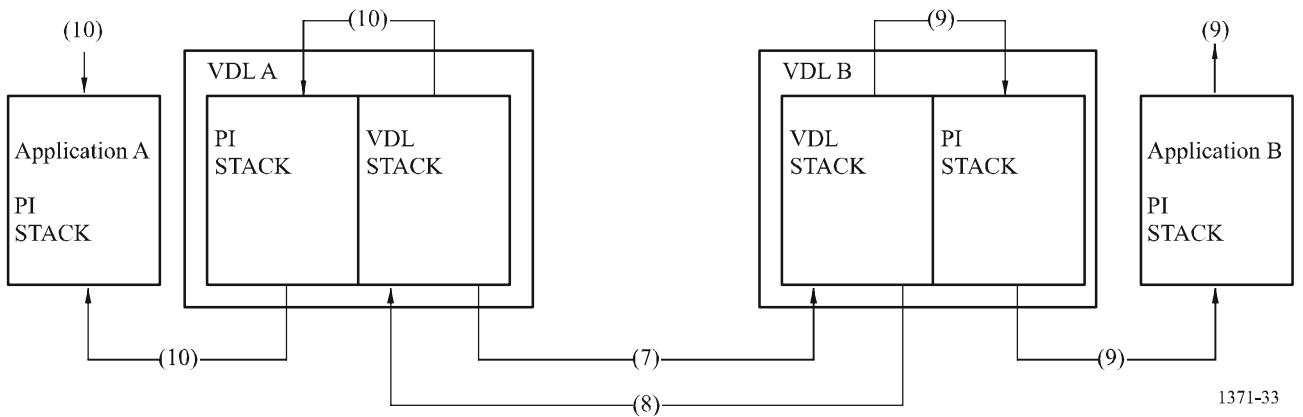

1371-33

Step 8: VDL B successfully receives Message 2 and returns a VDL-ACK with sequence number 2.

Step 9: VDL B delivers ABM (addressed binary message) message with sequence number 2 to Application B.

Step 10: VDL A delivers PI-ACK (OK) with sequence number 2 to Application A.

FIGURE 34

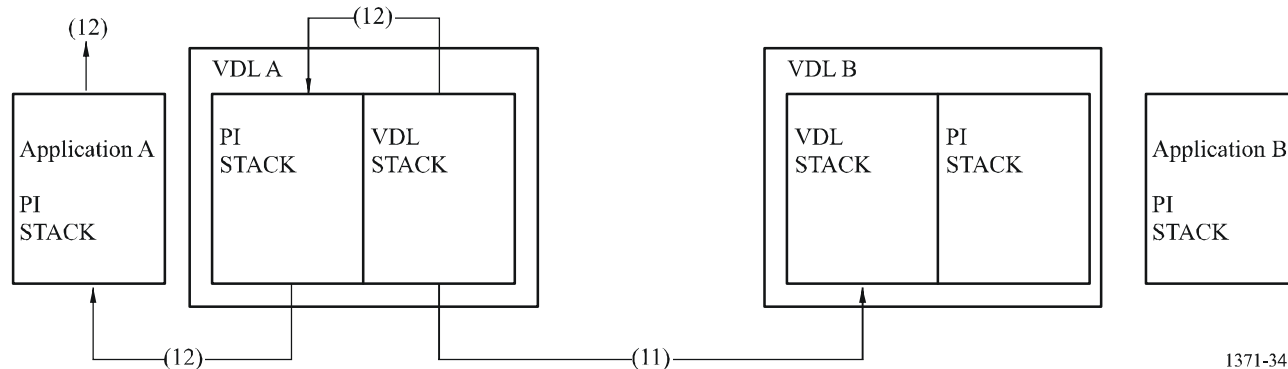

1371-34

Step 11: VDL A retransmits message, with sequence number 1, but does not receive a VDL-ACK from VDL B. It does this two times and is unsuccessful in delivering message.

Step 12: VDL A, upon failing the transmit transaction of message with sequence number 1, delivers a PI-ACK (FAIL) to Application A.

Annex 7

Class B AIS using CSTDMA technology

1 Definition

This annex describes a Class B AIS using carrier-sense TDMA (CSTDMA) technology, subsequently referred to as Class B “CS”. The CSTDMA technology requires that the Class B “CS” unit listens to the AIS network to determine if the network is free of activity and transmits only when the network is free. The Class B “CS” unit is also required to listen for reservation messages and comply with these reservations. This polite operation ensures that a Class B “CS” will be interoperable and will not interfere with equipment that complies with Annex 2.

2 General requirements

2.1 General

2.1.1 Capabilities of the Class B “CS” AIS

The Class B “CS” AIS station should be inter-operable and compatible with Class A or other Class B shipborne mobile AIS stations or any other AIS station operating on the AIS VHF data link. In particular, Class B “CS” AIS stations should receive other stations, should be received by other stations and should not degrade the integrity of the AIS VHF data link.

Transmissions from Class B “CS” AIS stations should be organized in “time periods” that are synchronized to VDL activity.

The Class B “CS” AIS should only transmit if it has verified that the time period intended for transmission does not interfere with transmissions made by equipment complying with Annex 2. Transmissions of the Class B “CS” AIS should not exceed one nominal time period (except when responding to a base station with Message 19).

An AIS station intended to operate in receive-only mode should not be considered a Class B shipborne mobile AIS station.

2.1.2 Modes of operation

The system should be capable of operating in a number of modes as described below subject to the transmission of messages by a competent authority. It should not retransmit received messages.

2.1.2.1 Autonomous and continuous mode

An “autonomous and continuous” mode for operation in all areas transmitting Message 18 for scheduled position reporting and Message 24 for static data.

The Class B “CS” AIS should be able to receive and process messages at any time except during time periods of own transmission.

2.1.2.2 Assigned mode

An “assigned” mode for operation in an area subject to a competent authority responsible for traffic monitoring such that:

- the reporting interval, silent mode and/or transceiver behaviour may be set remotely by that authority using group assignment by Message 23; or
- time periods are reserved by Message 20 (see § 3.18, Annex 8).

2.1.2.3 Interrogation mode

A “polling” or controlled mode where the Class B “CS” AIS responds to interrogations for Messages 18 and 24 from a Class A AIS or a base station. A base station interrogation for Message 19 specifying transmission offset should also be answered⁴. An interrogation overrides a silent period defined by Message 23 (see § 3.21, Annex 8).

A Class B “CS” AIS should not interrogate other stations.

3 Performance requirements

3.1 Composition

The B “CS” AIS should comprise:

- A communication processor, capable of operating in a part of the VHF maritime mobile service band, in support of short-range, VHF, applications.
- At least one transmitter and three receiving processes, two for TDMA and one for DSC on channel 70. The DSC process may use the receiving resources on a time-share basis as

⁴ Note that because Message 19 is a message occupying two time periods, this requires the reservation of the respective time periods by Message 20 prior to interrogation.

described in § 4.2.1.6. Outside the DSC receiving periods the two TDMA receiving processes should work independently and simultaneously on AIS channels A and B⁵.

- A means for automatic channel switching in the maritime mobile band (by Message 22 and DSC; Message 22 should have precedence). Manual channel switching should not be provided.
- An internal GNSS position sensor, which provides a resolution of one ten thousandth of a minute of arc and uses the WGS-84 datum (see § 3.3).

3.2 Operating frequency channels

The Class B “CS” AIS should operate at least on the frequency channels with 25 kHz bandwidth in the range from 161.500 MHz to 162.025 MHz of the RR Appendix 18 and in accordance with Recommendation ITU-R M.1084, Annex 4. The DSC receiving process should be tuned to channel 70.

The Class B “CS” AIS should automatically revert to receive-only mode on the channels AIS1 and AIS2 when commanded to operate at frequency channels outside its operating range and/or bandwidth.

3.3 Internal GNSS receiver for position reporting

The Class B “CS” AIS should have an internal GNSS receiver as source for position, COG, SOG.

The internal GNSS receiver may be capable of being differentially corrected, e.g. by evaluation of Message 17.

If the internal GNSS sensor is inoperative, the unit should not transmit Messages 18 and 24 unless interrogated by a base station⁶.

3.4 Identification

For the purpose of ship and message identification, the appropriate MMSI number should be used. The unit should only transmit if an MMSI is programmed.

3.5 AIS Information

3.5.1 Information content

The information provided by the Class B “CS” AIS should include (see Message 18, Table 67):

3.5.1.1 Static

- Identification (MMSI)
- Name of ship
- Type of ship
- Vendor ID (optional)
- Call sign
- Dimensions of ship and reference for position.

The default value for type of ship should be 37 (pleasure craft).

⁵ In some regions, the competent authority may not require DSC functionality.

⁶ Note that in this case the synchronization process will not take into account distance delays.

3.5.1.2 Dynamic

- Ship's position with accuracy indication and integrity status
- Time (UTC seconds)
- Course over ground (COG)
- Speed over ground (SOG)
- True heading (optional).

3.5.1.3 Configuration information

The following information about configuration and options active in the specific unit should be provided:

- AIS Class B "CS" unit
- Availability of minimum keyboard/display facility
- Availability of DSC channel 70 receiver
- Ability to operate in the whole marine band or 525 kHz band
- Ability to process channel management Message 22.

3.5.1.4 Short safety-related messages

- Short safety-related messages, if transmitted, should be in compliance with, § 3.12, Annex 8 and should use pre-configured contents.

It should not be possible for the user to alter the pre-configured contents.

3.5.2 Information reporting intervals

The Class B "CS" AIS should transmit position reports (Message 18) in reporting intervals of:

- 30 s if SOG > 2 knots
- 3 min if SOG ≤ 2 knots

provided that transmission time periods are available. A command received by Message 23 should override the reporting interval; a reporting interval of less than 5 s is not required.

Static data sub-messages 24A and 24B should be transmitted every 6 min in addition to and independent of the position report (see § 4.4.1). Message 24B should be transmitted within 1 min following Message 24A.

3.5.3 Transmitter shutdown procedure

An automatic transmitter shutdown should be provided in the case that a transmitter does not discontinue its transmission within 1 s of the end of its nominal transmission. This procedure should be independent of the operating software.

3.5.4 Static data input

Means should be provided to input and verify the MMSI prior to use. It should not be possible for the user to alter the MMSI once programmed.

4 Technical requirements

4.1 General

This section covers layers 1 to 4 (physical layer, link layer, network layer, transport layer) of the OSI model (see Annex 2, § 1).

4.2 Physical layer

The physical layer is responsible for the transfer of a bit stream from an originator to the data link.

4.2.1 Transceiver characteristics

General transceiver characteristics should be as specified in Table 31.

TABLE 31
Transceiver characteristics

Symbol	Parameter name	Value	Tolerance
PH.RFR	Regional frequencies (range of frequencies within RR Appendix 18) ⁽¹⁾ (MHz). Full range 156.025 to 162.025 MHz is also allowed. This capability will be reflected in Message 18	161.500 to 162.025	–
PH.CHS	Channel spacing (encoded according to RR Appendix 18 with footnotes) ⁽²⁾ (kHz) Channel bandwidth	25	–
PH.AIS1	AIS 1 (default channel 1) (2 087) ⁽²⁾ (MHz)	161.975	±3 ppm
PH.AIS2	AIS 2 (default channel 2) (2 088) ⁽²⁾ (MHz)	162.025	±3 ppm
PH.BR	Bit rate (bit/s)	9 600	±50 ppm
PH.TS	Training sequence (bits)	24	–
	GMSK transmitter BT-product	0.4	
	GMSK receiver BT-product	0.5	
	GMSK modulation index	0.5	

⁽¹⁾ See Recommendation ITU-R M.1084, Annex 4.

⁽²⁾ In some Regions, the competent authority may not require DSC functionality.

4.2.1.1 Dual channel operation

The AIS should be capable of operating on two parallel channels in accordance with § 4.41. Two separate TDMA receive channels or processes should be used to simultaneously receive information on two independent frequency channels. One TDMA transmitter should be used to alternate TDMA transmissions on two independent frequency channels.

Data transmissions should default to AIS 1 and AIS 2 unless otherwise specified by a competent authority, as described in § 4.4.1 and § 4.6.

4.2.1.2 Bandwidth

The Class B AIS should operate on 25 kHz channels according to Recommendation ITU-R M.1084-4 and RR Appendix 18.

4.2.1.3 Modulation scheme

The modulation scheme is bandwidth adapted frequency modulated Gaussian filtered minimum shift keying (GMSK/FM). The NRZI encoded data should be GMSK coded before frequency modulating the transmitter.

4.2.1.4 Training sequence

Data transmission should begin with a 24-bit demodulator training sequence (preamble) consisting of one segment synchronization. This segment should consist of alternating zeros and ones (0101....). This sequence always starts with a 0.

4.2.1.5 Data encoding

The NRZI waveform is used for data encoding. The waveform is specified as giving a change in the level when a zero (0) is encountered in the bit stream.

Forward-error correction, interleaving or bit scrambling is not used.

4.2.1.6 DSC operation

The Class B “CS” AIS should be capable of receiving DSC channel management commands. It should either have a dedicated receive process, or it should be capable of retuning its TDMA receivers to channel 70 on a time-sharing basis, with each TDMA receiver taking alternate turns to monitor channel 70 (for details see § 4.6)⁷.

4.2.2 Transmitter requirements

4.2.2.1 Transmitter parameters

Transmitter parameters should be as given in Table 32.

TABLE 32
Transmitter parameters

Transmitter parameters	Value	Condition
Frequency error	±500 Hz	
Carrier power	33 dBm ±1.5 dB	Conducted
Modulation spectrum	-25 dBW -60 dBW	$\Delta f_c < \pm 10$ kHz ± 25 kHz < $\Delta f_c < \pm 62.5$ kHz
Modulation accuracy	< 3 400 Hz 2 400 ±480 Hz 2 400 ±240 Hz 1 740 ±175 Hz 2 400 ±240 Hz	Bit 0, 1 Bit 2, 3 Bit 4 ... 31 Bit 32 ... 199: For a bit pattern of 0101... For a bit pattern of 00001111...
Power versus time characteristics	Transmission delay: 2 083 µs Ramp up: ≤ 313 µs Ramp down: ≤ 313 µs Transmission duration: ≤ 23 333 µs	Nominal 1-time period transmission
Spurious emissions	-36 dBm -30 dBm	9 kHz ... 1 GHz 1 GHz ... 4 GHz

⁷ In some regions, the competent authority may not require DSC functionality.

4.2.3 Receiver parameters

Receiver parameters should be as given in Table 33.

4.3 Link layer

The link layer specifies how data should be packaged in order to apply error detection to the data transfer. The link layer is divided into three sub-layers.

4.3.1 Link sub-layer 1: medium access control

The medium access control (MAC) sub-layer provides a method for granting access to the data transfer medium, i.e. the VHF data link. The method used should be TDMA.

4.3.1.1 Synchronization

Synchronization should be used to determine the nominal start of the CS time period (T_0).

TABLE 33
Receiver parameters

Receiver parameters	Values		
	Results	Wanted signal	Unwanted signal(s)
Sensitivity	20% per	-107 dBm -104 dBm at ± 500 Hz offset	
Error at high input levels	2% per	-77 dBm	–
	10% per	-7 dBm	–
Co-channel rejection	20% per	-101 dBm	-111 dBm -111 dBm at ± 1 kHz offset
Adjacent channel selectivity	20% per	-101 dBm	-31 dBm
Spurious response rejection	20% per	-101 dBm	-31 dBm 50 MHz ... 520 MHz
Intermodulation response rejection	20% per	-101 dBm	-36 dBm
Blocking and desensitization	20% per	-101 dBm	-23 dBm (<5 MHz) -15 dBm (>5 MHz)
Spurious emissions	-57 dBm	9 kHz ... 1 GHz	
	-47 dBm	1 GHz ... 4 GHz	

4.3.1.1.1 Sync mode 1: AIS stations other than Class B “CS” are received

If signals from other AIS stations complying with Annex 2 are received, the Class B “CS” should synchronize its time periods to their scheduled position reports (suitable account should be taken of the propagation delays from the individual stations). This applies to message types 1, 2, 3, 4, 18 and 19 as far as they are providing position data and have not been repeated (repeat indicator = 0).

Synchronization jitter should not exceed ± 3 bits ($\pm 312 \mu\text{s}$) from the average of the received position reports. That average should be calculated over a rolling 60 s period.

If these AIS stations are no longer received, the unit should maintain synchronization for a minimum of 30 s and switch back to sync mode 2 after that.

Other synchronization sources fulfilling the same requirements are allowed (optionally) instead of the above.

4.3.1.1.2 Sync mode 2: no station other than Class B “CS” is received

In the case of a population of Class B “CS” stations alone (in the absence of any other class of station that can be used as a synchronization source) the Class B “CS” station should determine the start of time periods (T_0) according to its internal timing.

If the Class B “CS” unit receives an AIS station that can be used as a synchronization source (being in sync mode 2) it should evaluate timing and synchronize its next transmission to this station.

Time periods reserved by a base station should still be respected.

4.3.1.2 CS detection method

Within a time window of 1 146 μs starting at 833 μs and ending at 1 979 μs after the start of the time period intended for transmission (T_0) the AIS Class B “CS” should detect if that time period is used (CS detection window).

NOTE 1 – Signals within the first 8 bits (833 μs) of the time period are excluded from the decision (to allow for propagation delays and ramp down periods of other units).

The Class B “CS” AIS should not transmit on any time period in which, during the CS detection window, a signal level greater than the “CS detection threshold” (§ 4.3.1.3) is detected.

The transmission of a CSTDMA packet should commence 20 bits ($T_A = 2\,083\ \mu\text{s} + T_0$) after the nominal start of the time period (see Fig. 35).

FIGURE 35
Carrier sense timing

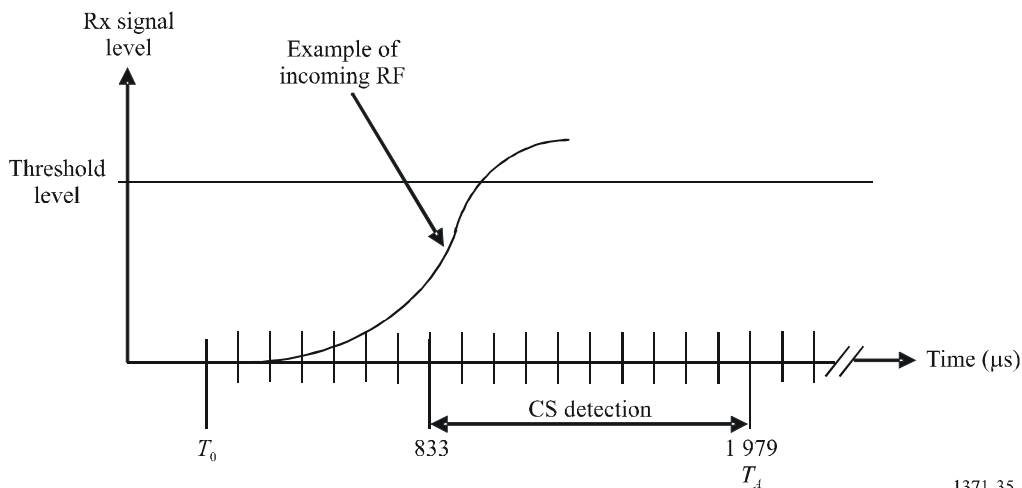

1371-35

4.3.1.3 CS detection threshold

The CS detection threshold should be determined over a rolling 60 s interval on each Rx channel separately. The threshold should be determined by measuring the minimum energy level (representing the background noise) plus an offset of 10 dB. The minimum CS detection threshold

should be -107 dBm and background noise should be tracked for a range of at least 30 dB (which results in a maximum threshold level of -7 dBm)⁸.

4.3.1.4 VDL access

The transmitter should begin transmission by turning on the RF power immediately after the duration of the carrier sense window (T_A).

The transmitter should be turned off after the last bit of the transmission packet has left the transmitting unit (nominal transmission end T_E assuming no bit stuffing).

The access to the medium is performed as shown in Fig. 36 and Table 34:

FIGURE 36
Power versus time mask

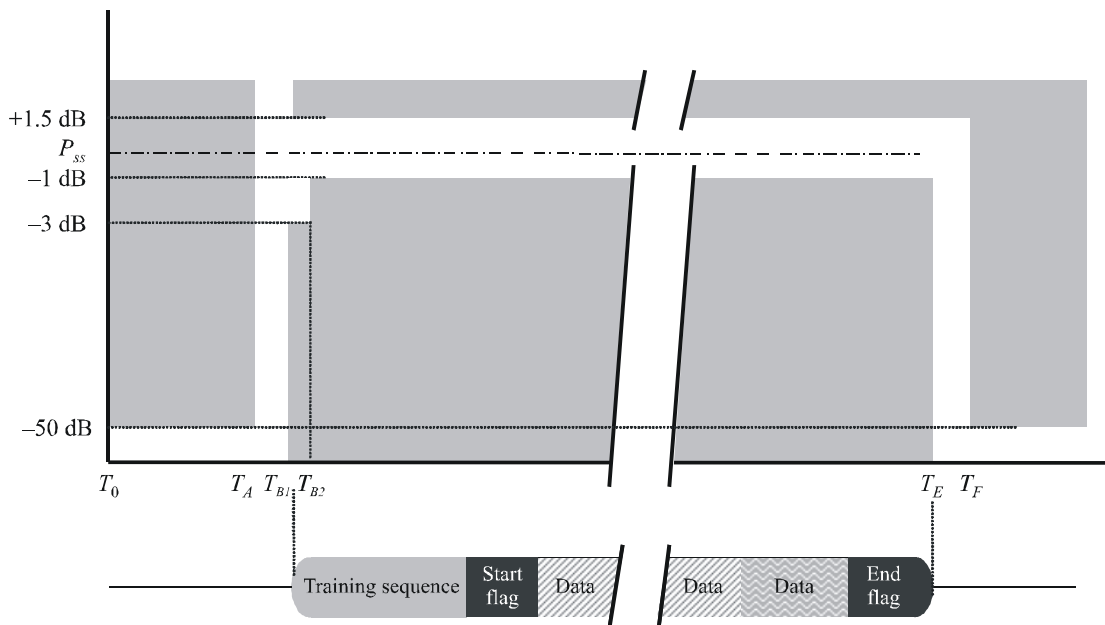

1371-36

⁸ The following example is compliant with the requirement:

Sample the RF signal strength at a rate >1 kHz, average the samples over a sliding 20 ms period and over a 4 s interval determine the minimum period value. Maintain a history of 15 such intervals. The minimum of all 15 intervals is the background level. Add a fixed 10 dB offset to give the CS detection threshold.

TABLE 34

Definition of timings for Fig. 36

Reference	Bits	Time (ms)	Definition	
T_0 to T_A	0	0	Start of candidate transmission time period Power should not exceed -50 dB of P_{ss}	
T_A to T_B	20	2 083	Begin of upramping	
T_B	T_{B1}	23	2 396	Power should reach within $+1.5$ or -3 dB of P_{ss}
	T_{B2}	25	2 604	Power should reach within $+1.5$ or -1 dB of P_{ss}
T_E (plus 1 stuffing bit)	248	25 833	Power should still remain within $+1.5$ or -1 dB of P_{ss}	
T_F (plus 1 stuffing bit)	251	26 146	Power should reach -50 dB of steady state RF output power (P_{ss}) and stay below this	

There should be no modulation of the RF after the termination of transmission (T_E) until the power has reached zero and next time period begins (T_G).

4.3.1.5 VDL state

The VDL state is based on the result of the carrier sense detection (see § 4.3.1.2) for a time period. A VDL time period can be in one of the following states:

- FREE: time period is available and has not been identified as used in reference to § 4.3.1.2.
- USED: VDL has been identified as used in reference to § 4.3.1.2.
- UNAVAILABLE: time periods should be indicated as “UNAVAILABLE” if they are reserved by base stations using Message 20 regardless of their range.

Time periods indicated as “UNAVAILABLE” should not be considered as a candidate time period for use by own station and may be used again after a time-out. The time-out should be 3 min if not specified or as specified in Message 20.

4.3.2 Link sub-layer 2: data link service

The data link service (DLS) sub-layer provides methods for:

- data link activation and release;
- data transfer; or
- error detection and control.

4.3.2.1 Data link activation and release

Based on the MAC sub-layer the DLS will listen, activate or release the data link. Activation and release should be in accordance with § 4.3.1.4.

4.3.2.2 Data transfer

Data transfer should use a bit-oriented protocol which is based on the high-level data link control (HDLC) as specified by ISO/IEC 3309: 1993 – Definition of packet structure. Information packets (I-Packets) should be used with the exception that the control field is omitted (see Fig. 37).

FIGURE 37
Transmission packet

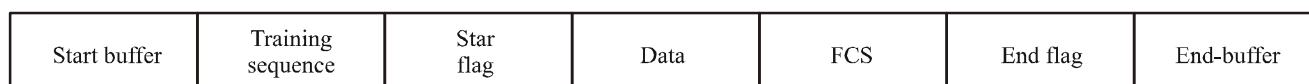

1371-37

4.3.2.2.1 Bit stuffing

The bit stream should be subject to bit stuffing. This means that if five consecutive ones (1's) are found in the output bit stream, a zero should be inserted. This applies to all bits except the data bits of HDLC flags (start flag and end flag, see Fig. 37).

4.3.2.2.2 Packet format

Data is transferred using a transmission packet as shown in Fig. 37.

The packet should be sent from left to right. This structure is identical to the general HDLC structure, except for the training sequence. The training sequence should be used in order to synchronize the VHF receiver as described in § 4.2.1.4. The total length of the default packet is 256 bits. This is equivalent to 26.7 ms.

4.3.2.2.3 Start-buffer

The start-buffer (refer to Table 35) is 23 bits long and consists of:

- CS-delay 20 bits
 - Reception delay (sync jitter + distance delay)
 - Own synchronization jitter (relative to synchronization source)
 - Ramp-up (received message)
 - CS detection window
 - Internal processing delay
- Ramp-up (own transmitter) 3 bits

TABLE 35
Start buffer

Sequence	Description	Bits	Note
1	Reception delay (synchronization jitter + distance delay)	5	Class A: 3 bits of jitter + 2 bits (30 NM) distance delay; base station: 1 bit of jitter + 4 bits (60 NM) distance delay
2	Own synchronization jitter (relative to synchronization source)	3	3 bits according to § 4.3.1.1
3	Ramp-up (received message)	8	Refer to Annex 2, start of detection window
4	Detection window	3	
5	Internal processing delay	1	
6	Ramp-up (own transmitter)	3	
	Total	23	

4.3.2.2.4 Training sequence

The training sequence should be a bit pattern consisting of alternating 0's and 1's (010101010...).

Twenty-four bits of preamble are transmitted prior to sending the flag. This bit pattern is modified due to the NRZI mode used by the communication circuit (see Fig. 38).

FIGURE 38

Training sequence

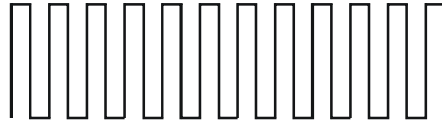

a) Unmodified bit pattern

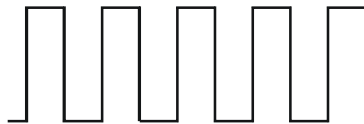

b) Modified bit pattern by NRZI

1371-38

4.3.2.2.5 Start flag

The start flag should be 8 bits long and consists of a standard HDLC flag. It is used to detect the start of a transmission packet. The start flag consists of a bit pattern, 8 bits long: 01111110 (7Eh). The flag should not be subject to bit stuffing, although it consists of 6 bits of consecutive ones (1's).

4.3.2.2.6 Data

The data portion in the default transmission packet transmitted in one-time period is a maximum of 168 bits.

4.3.2.2.7 Frame check sequence

The frame check sequence (FCS) uses the cyclic redundancy check (CRC) 16-bit polynomial to calculate the checksum as defined in ISO/IEC 3309: 1993. All the CRC bits should be pre-set to one (1) at the beginning of a CRC calculation. Only the data portion should be included in the CRC calculation (see Fig. 39).

FIGURE 39
Transmission timing

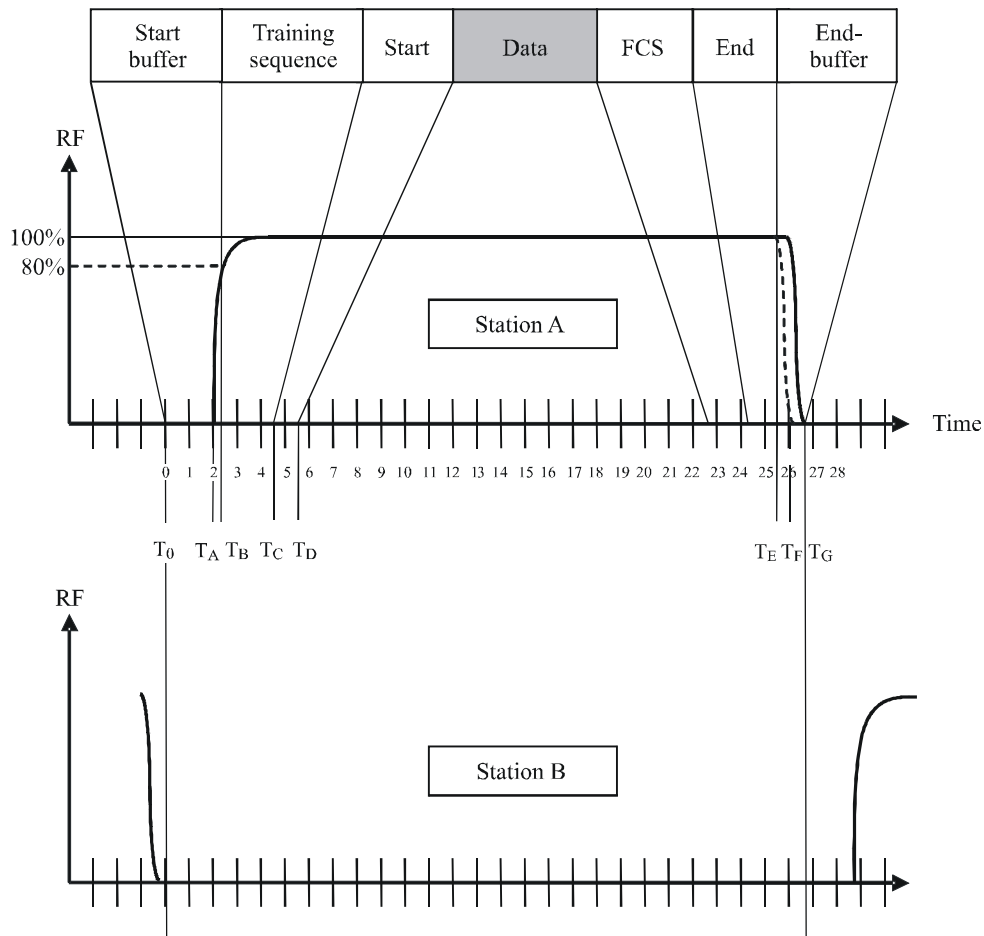

1371-39

4.3.2.2.8 End flag

The end flag is identical to the start flag as described in § 4.3.2.2.5.

4.3.2.2.9 End-buffer

- bit stuffing: 4 bits.

(The probability of 4 bits of bit stuffing is only 5% greater than that of 3 bits; refer to Annex 2 § 3.2.2.8.1.)

- ramp down: 3 bits
- distance delay: 2 bits.

(A buffer value of 2 bits is reserved for a distance delay equivalent to 30 NM for own transmission.)

A repeater delay is not applicable (duplex repeater environment is not supported).

4.3.2.3 Summary of the transmission packet

The data packet is summarized as shown in Table 36:

TABLE 36
Summary of the transmission packet

Action	Bits	Explanation
<i>Start-buffer:</i>		
CS-delay	20	T_0 to T_A in Fig. 40
Ramp up	3	T_A to T_B in Fig. 40
Training sequence	24	Necessary for synchronization
Start flag	8	In accordance with HDLC (7Eh)
Data	168	Default
CRC	16	In accordance with HDLC
End flag	8	In accordance with HDLC (7Eh)
<i>End-buffer:</i>		
Bit stuffing	4	
Ramp down	3	
Distance delay	2	
Total	256	

4.3.2.4 Transmission timing

Table 37 and Fig. 39 show the timing of the default transmission packet (one-time division).

TABLE 37
Transmission timing

$T(n)$	Time (μ s)	Bit	Description
T_0	0	0	Start of time division; beginning of start buffer
T_A	2 083	20	Start of transmission (RF power is applied)
T_B	2 396	23	End of start buffer; RF power and frequency stabilization time, beginning of training sequence
T_C	4 896	47	Beginning of start flag
T_D	5 729	55	Beginning of data
T_E	25 729	247	Beginning of end buffer; nominal end of transmission (assuming 0 bit stuffing)
T_F	26 042	250	Nominal end of ramp down (power reaches -50 dBc)
T_G	26 667	256	End of time period, start of next time period

4.3.2.5 Long transmission packets

Autonomous transmissions are limited to one-time period. When responding to an interrogation by a base station for Message 19, the response may occupy two-time periods.

4.3.2.6 Error detection and control

Error detection and control should be handled using the CRC polynomial as described in § 4.3.2.2.7.

CRC errors should result in no further action by the Class B “CS”.

4.3.3 Link sub-layer 3 – link management entity

The link management entity (LME) controls the operation of the DLS, MAC and the physical layer.

4.3.3.1 Access algorithm for scheduled transmissions

The Class B “CS” should use a CSTDMA access using transmission periods, which are synchronized to periods of RF activity on the VDL.

The access algorithm is defined by the following parameters in Table 38:

TABLE 38
Access parameters

Term	Description	Value
Reporting interval (RI)	Reporting interval as specified in § 3.5.2	5 s ... 10 min
Nominal transmission time (NTT)	Nominal time period for transmission defined by RI	
Transmission interval (TI)	Time interval of possible transmission periods, centred around NTT	$TI = \frac{RI}{3}$ or 10 s, whichever is less
Candidate period (CP)	Time period where a transmission attempt is made (excluding time periods indicated unavailable)	
Number of CP in TI		10

The CSTDMA algorithm should follow the rules given below (see Fig. 40):

- 1 Randomly define 10 CP in the TI.
- 2 Starting with the first CP in TI, test for CS, § 4.3.1.2, and transmit if the status of CP is “unused”, otherwise wait for the next CP.
- 3 Transmission should be abandoned if all 10 CPs are “used”.

FIGURE 40
Example of CSTDMA access

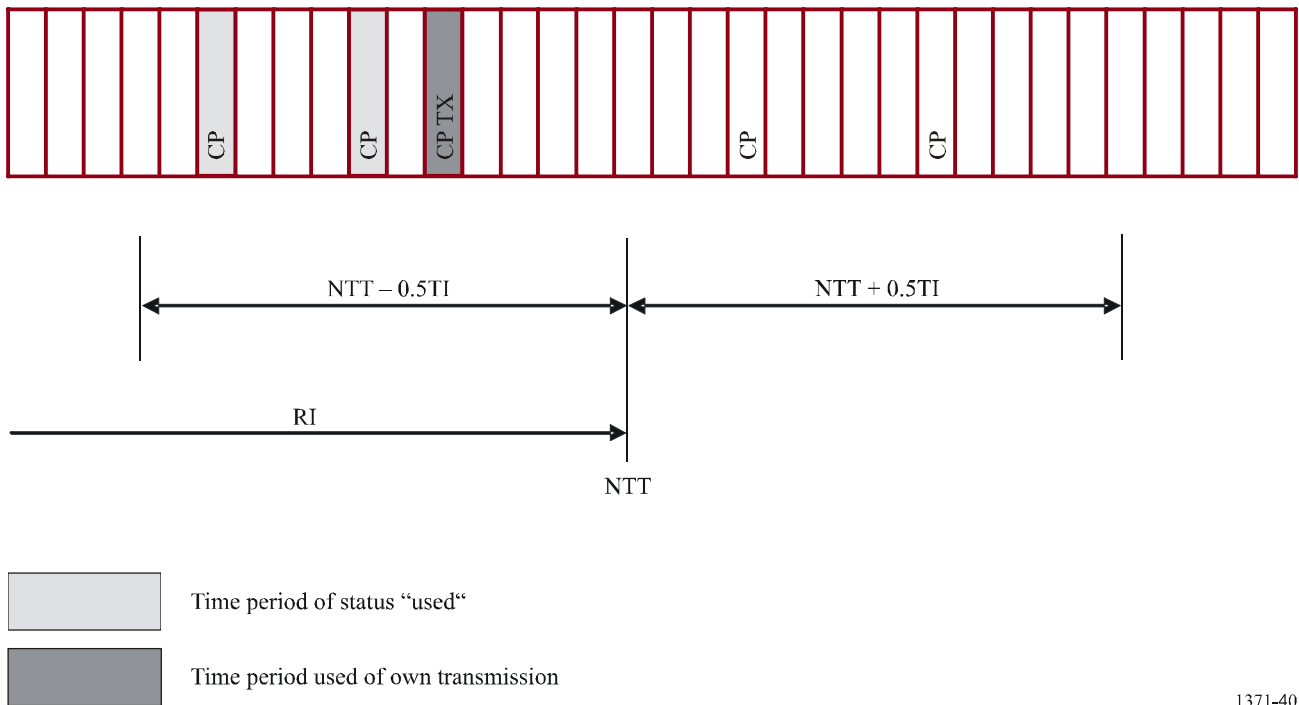

1371-40

4.3.3.2 Access algorithm for unscheduled transmissions

Unscheduled transmissions, except responses to interrogations by a base station, should be performed by assigning a nominal transmission time within 25 s of the request and should use the access algorithm described in § 4.3.2.1.

If the option to process Message 12 is implemented, an acknowledgement Message 13 should be transmitted in response to Message 12 on the same channel with up to 3 repetitions of the access algorithm if needed.

4.3.3.3 Modes of operation

There should be three modes of operation.

- Autonomous (default mode)
- Assigned
- Interrogation

4.3.3.3.1 Autonomous

A station operating autonomously should determine its own schedule for the transmission of its position reports.

4.3.3.3.2 Assigned

A station operating in the assigned mode should use a transmission schedule assigned by a competent authority's base station. This mode is initiated by a group assignment command (Message 23).

The assigned mode should affect the transmission of scheduled position reports, except the Tx/Rx mode and the quiet time command, which also affect static reports.

If a station receives this group assignment command and belongs to the group addressed by region and selection parameters it should enter into assigned mode which should be indicated by setting the “Assigned Mode Flag” to “1”.

To determine whether this group assignment command applies to the recipient station it should evaluate all selector fields concurrently.

When commanded to a specific transmission behaviour (Tx/Rx mode or reporting interval), the mobile station should tag it with a time-out, randomly selected between 4 and 8 min after the first transmission⁹. After the time-out has elapsed the station should return to autonomous mode.

When commanded to a specific reporting rate, the AIS should transmit the first position report with assigned rate after a time randomly selected between the time the Message 23 has been received and the assigned interval to avoid clustering.

Any individual assignment command received should take precedence over any group assignment command received; i.e. the following cases should be applied:

- if Message 22 is individually addressed, the Tx/Rx mode field setting of Message 22 should take precedence over the Tx/Rx mode field setting of Message 23;
- if Message 22 with regional settings is received, the Tx/Rx mode field setting of Message 23 should take precedence over the Tx/Rx mode field setting of Message 22. In the case of Tx/Rx mode field, the receiving station reverts to its previous Tx/Rx mode regional operating setting after the Message 23 assignment has expired.

When a Class B “CS” station receives a quiet time command, it should continue to schedule NTT periods but should not transmit Messages 18 and 24 on either channel for the time commanded. Interrogations should be answered during the quiet period. Transmissions of safety related messages may still be possible. After the quiet time has elapsed, transmissions should be resumed using the transmission schedule as maintained during the quiet period.

Subsequent quiet time commands received during the first commanded quiet time should be ignored.

The quiet time command should override a reporting rate command.

4.3.3.3.3 Interrogation mode

A station should automatically respond to interrogation messages (Message 15) from an AIS station (see Table 62, Annex 8). Operation in the interrogation mode should not conflict with operation in the other two modes. The response should be transmitted on the channel where the Interrogation message was received.

If interrogated for Message 18 or 24 with no offset specified in Message 15, the response should be transmitted within 30 s using the access algorithm as described in § 4.3.3.2. If no free candidate period has been found, one transmission retry should be performed after 30 s.

If interrogated by a base station with an offset given in Message 15, the response should be transmitted in the specified time period without applying the access algorithm as described in § 4.3.3.2.

⁹ Because of the time-out, assignments may be reissued by the competent authority as needed. If a Message 23 commanding a reporting interval of 6 or 10 min is not refreshed by the base station, the assigned station will resume normal operation after time-out and thus not establish the assigned rate.

An interrogation for Message 19 should only be responded to if the interrogation Message 15 contains an offset to the time period in which the response should be transmitted¹⁰.

Interrogations for the same message received before own response has been transmitted may be ignored.

4.3.3.4 Initialization

At power on, a station should monitor the TDMA channels for one (1) minute to synchronize on received VDL-transmissions (§ 4.3.1.1) and to determine the CS detection threshold level (§ 4.3.1.3). The first autonomous transmission should always be the scheduled position report (Message 18) see § 3.16, Annex 8.

4.3.3.5 Communication state for CS access

Because Class B “CS” does not use any Communication state information, the communication state field in Message 18 should be filled with the default value¹¹ “1100000000000000110” and the communication state selector flag field filled with “1”.

4.3.3.6 VDL message use

Table 39 shows how the messages defined in Annex 8 should be used by a Class B “CS” shipborne mobile AIS device.

TABLE 39
Use of VDL messages by a Class B “CS” AIS

Message No.	Name of message	Annex 8 reference	Receive and process (1)	Transmit by own station	Remark
0	Undefined				
1	Position report (Scheduled)	§ 3.1	Optional	No	
2	Position report (Assigned)	§ 3.1	Optional	No	
3	Position report (When interrogated)	§ 3.1	Optional	No	
4	Base station report	§ 3.2	Optional	No	
5	Static and voyage related data	§ 3.3	Optional	No	
6	Addressed binary message	§ 3.4	No	No	
7	Binary acknowledge	§ 3.5	No	No	
8	Binary broadcast message	§ 3.6	Optional	No	

¹⁰ This can only be done by a base station. The base station will reserve time periods by Message 20 prior to interrogation.

¹¹ A Class B “CS” station by default reports sync state 3 and does not report “number of received stations”. Therefore it will not be used as sync source for other stations.

TABLE 39 (continued)

Message No.	Name of message	Annex 8 reference	Receive and process (1)	Transmit by own station	Remark
9	Standard SAR aircraft position report	§ 3.7	Optional	No	
10	UTC and date inquiry	§ 3.8	No	No	
11	UTC/Date response	§ 3.2	Optional	No	
12	Safety related addressed message	§ 3.10	Optional	No	NOTE 1 – Information can also be transferred via Message 14
13	Safety related acknowledge	§ 3.5	No	Optional	Should be transmitted if the option to process Message 12 is implemented
14	Safety related broadcast message	§ 3.12	Optional	Optional	Transmit with predefined text only, see § 4.3.3.7
15	Interrogation	§ 3.13	Yes	No	Class B “CS” should respond to interrogations for Message 18 and Message 24. It should also respond to interrogations for Message 19 by a base station
	Assigned mode command	§ 3.21	No	No	Message 23 is applicable to the “CS”
17	DGNSS broadcast binary message	§ 3.15	Optional	No	
18	Standard Class B equipment position report	§ 3.16	Optional	Yes	A Class B “CS” AIS should indicate “1” for “CS” in flag bit 143
19	Extended Class B equipment position report	§ 3.17	Optional	Yes	Transmit ONLY as response on base station interrogation
20	Data link management message	§ 3.18	Yes	No	
21	Aids-to-navigation report	§ 3.19	Optional	No	
22	Channel management message	§ 3.20	Yes	No	Use of that function may be different in certain regions
23	Group assignment	§ 3.21	Yes	No	
24	Class B “CS” static data	§ 3.22	Optional	Yes	Part A and Part B

TABLE 39 (*end*)

Message No.	Name of message	Annex 8 reference	Receive and process (1)	Transmit by own station	Remark
25	Single slot binary message	§ 3.23	Optional	No	
26	Mult. slot binary message with Communications State	§ 3.24	No	No	
27	Position report for long-range applications	§ 3.25	No	No	
28-63	Undefined	None	No	No	Reserved for future use

(1) "Receive and process" in this table means functionality visible for the user, e.g. output to an interface or display. For synchronization it is necessary to receive and internally process messages according to § 4.3.1.1; this applies to Messages 1, 2, 3, 4, 18, 19.

4.3.3.7 Use of safety related message, Message 14 (optional)

The data contents of Message 14 if implemented should be predefined and the transmission should not exceed one-time period. Table 40 specifies the maximum number of data bits used for Message 14 and is based on the assumption that the theoretical maximum of stuffing bits will be needed.

TABLE 40

Number of data bits for use with Message 14

Number of time periods	Maximum data bits	Stuffing bits	Total buffer bits
1	136	36	56

The Class B "CS" AIS should only accept the initiation of a Message 14 once a minute by a user manual input. Automatic repetition is not allowed.

The Message 14 may have precedence over Message 18.

4.4 Network layer

The network layer should be used for:

- establishing and maintaining channel connections;
- management of priority assignments of messages;
- distribution of transmission packets between channels;
- data link congestion resolution.

4.4.1 Dual channel operation

The normal default mode of operation should be a two-channel operating mode, where the AIS simultaneously receives on both channels A and B in parallel.

The DSC process may use the receiving resources on a time-share basis as described in § 4.6. Outside the DSC receiving periods the two TDMA receiving processes should work independently and simultaneously on channels A and B.

For periodic repeated messages, the transmissions should alternate between channels A and B. The alternating process should be independent for Messages 18 and 24.

Transmission of complete Message 24 should alternate between channels (all sub-messages to be transmitted on the same channel before alternating to the other channel).

Channel access is performed independently on each of the two parallel channels.

Responses to interrogations should be transmitted on the same channel as the initial message.

For non-periodic messages other than those referenced above, the transmissions of each message, regardless of message type, should alternate between channels A and B.

4.4.2 Channel management

Channel management should be done according to Annex 2, § 4.1 except:

- Channel management should be by Message 22 or DSC command. No other means should be used.
- The Class B “CS” AIS is only required to operate in the band specified in § 3.2 with a channel spacing of 25 kHz. It should stop transmitting if commanded to a frequency outside its operating capability.

TABLE 41

Channel management transitional behaviour

		Step	Region 1 Channel A (frequency 1)	Region 1 Channel B (frequency 2)	Region 2 Channel A (frequency 3)	Region 2 Channel B (frequency 4)
Region 1		A	1	1		
	Transitional zone	B	2		2	
Region 2	Transitional zone	C	2		2	
		D			1	1

- 1 Transmit with nominal reporting interval.
- 2 Transmit with half the reporting interval.

When entering (Step A to B) or leaving (Step C to D) a transitional zone the Class B “CS” AIS should continue to evaluate the CS threshold taking into account the noise level of the old channel initially and the new channel as time progresses. It should continuously transmit (on frequency 1 and frequency 3 in Step B) with the required rate maintaining its schedule.

4.4.3 Distribution of transmission packets

4.4.3.1 Assigned reporting intervals

A competent authority may assign reporting intervals to any mobile station by transmitting group assignment Message 23. An assigned reporting interval should have precedence over the nominal reporting rate; a reporting interval of less than 5 s is not required.

The Class B “CS” should react on next shorter/next longer commands only once until time-out.

4.4.4 Data link congestion resolution

The Class B “CS” AIS access algorithm as described in § 4.3.3.1 guarantees that the time period intended for transmission does not interfere with transmissions made by stations complying with Annex 2. Additional congestion resolution methods are not required and should not be used.

4.5 Transport layer

The transport layer should be responsible for:

- converting data into transmission packets of correct size;
- sequencing of data packets;
- interfacing protocol to upper layers.

4.5.1 Transmission packets

A transmission packet is an internal representation of some information, which can ultimately be communicated to external systems. The transmission packet is dimensioned so that it conforms to the rules of data transfer.

The transport layer should convert data intended for transmission, into transmission packets.

The Class B “CS” AIS should only transmit Messages 18, 19 and 24 and may optionally transmit Message 14.

4.5.2 Sequencing of data packets

The Class B “CS” AIS is periodically transmitting the standard position report Message 18.

This periodic transmission should use the access scheme described in § 4.3.3.1. If a transmission attempt fails because of, e.g. high channel load, this transmission should not be repeated. Additional sequencing is not necessary.

4.6 DSC channel management

4.6.1 DSC functionality

The AIS should be capable of performing regional channel designation and regional area designation as defined in Annex 3; DSC transmissions (acknowledgements or responses) should not be broadcast.

The DSC functionality should be accomplished by using a dedicated DSC receiver or by time-sharing the TDMA channels. The primary use of this feature is to receive channel management messages when AIS 1 and/or AIS 2 are not available.

4.6.2 DSC time-sharing

In the case of equipment, which implements the DSC receive function by time-sharing the TDMA receive channels, the following should be observed.

One of the receive processes should monitor DSC channel 70 for the 30 s time periods in Table 42. This selection should be swapped between the two receive processes.

TABLE 42
DSC monitoring times

Minutes past UTC hour
05:30-05:59
06:30-06:59
20:30-20:59
21:30-21:59
35:30-35:59
36:30-36:59
50:30-50:59
51:30-51:59

If the AIS is utilizing this time-sharing method to receive DSC, AIS transmissions should still be performed during this period. In order to accomplish the CS algorithm, the AIS receivers' channel switching time should be such that the DSC monitoring is not interrupted for more than 0.5 s per AIS transmission¹².

If a DSC command is received, the AIS transmission may be delayed accordingly.

These periods should be programmed into the unit during its configuration. Unless some other monitoring schedule is defined by a competent authority, the default monitoring times in Table 42 should be used. The monitoring schedule should be programmed into the unit during initial configuration. During the DSC monitoring times, scheduled autonomous or assigned transmissions, and responses to interrogations should continue.

The AIS device should be capable of processing message type 104 with expansion symbol Nos. 00, 01, 09, 10, 11, 12 and 13 of Table 5 of Recommendation ITU-R M.825 (DSC channel management test signal number 1 for this test) by performing operations in accordance with Annex 2, § 4.1 with the regional frequencies and regional boundaries specified by these calls (see § 1.2, Annex 3).

¹² During the DSC monitoring periods, TDMA receptions will necessarily be disrupted due to this time-sharing of the AIS receiver. Proper performance of the AIS assumes that DSC channel management messages are transmitted in compliance with Recommendation ITU-R M.825 which requires duplicate messages with a gap of 0.5 s between the two transmissions. This will insure that the AIS can receive at least one DSC channel management message during each DSC monitoring time without any affects to its AIS transmit performance.

Annex 8

AIS messages

1 Message types

This annex describes all messages on the TDMA data link. The messages in Table 43 uses the following columns:

- Message ID: message identifier as defined in § 3.3.7.1, Annex 2.
- Name: name of the message. Can also be found in § 3.
- Description: brief description of the message. See § 3 for detailed description of each message.
- Priority: priority as defined in § 4.2.3, Annex 2.
- Access scheme: this column indicates how a station may select slots for transmission of this message. The access scheme used for the selection of slots does not determine the message type nor the communication state of the message transmissions in those slots.
- Communication state: specifies which communication state is used in the message. If a message does not contain a communication state, it is stated as not applicable, N/A. Communication state, where applicable, indicates an expected future use of that slot. Where no communication state is indicated the slot is immediately available for future use.

M/B: M: transmitted by mobile station

B: transmitted by Base station.

2 Message summary

The defined messages are summarized in Table 43.

TABLE 43

Message ID	Name	Description	Priority	Access scheme	Communication state	M/B
1	Position report	Scheduled position report; (Class A shipborne mobile equipment)	1	SOTDMA, RATDMA, ITDMA ⁽¹⁾	SOTDMA	M
2	Position report	Assigned scheduled position report; (Class A shipborne mobile equipment)	1	SOTDMA ⁽⁹⁾	SOTDMA	M
3	Position report	Special position report, response to interrogation; (Class A shipborne mobile equipment)	1	RATDMA ⁽¹⁾	ITDMA	M
4	Base station report	Position, UTC, date and current slot number of base station	1	FATDMA ^{(3), (7)} , RATDMA ⁽²⁾	SOTDMA	B

TABLE 43 (continued)

Message ID	Name	Description	Priority	Access scheme	Communication state	M/B
5	Static and voyage related data	Scheduled static and voyage related vessel data report; (Class A shipborne mobile equipment)	4 ⁽⁵⁾	RATDMA, ITDMA ⁽²⁾	N/A	M
6	Binary addressed message	Binary data for addressed communication	4	RATDMA ⁽¹⁰⁾ , FATDMA, ITDMA ⁽²⁾	N/A	M/B
7	Binary acknowledgement	Acknowledgement of received addressed binary data	1	RATDMA, FATDMA, ITDMA ⁽²⁾	N/A	M/B
8	Binary broadcast message	Binary data for broadcast communication	4	RATDMA ⁽¹⁰⁾ , FATDMA, ITDMA ⁽²⁾	N/A	M/B
9	Standard SAR aircraft position report	Position report for airborne stations involved in SAR operations, only	1	SOTDMA, RATDMA, ITDMA ⁽¹⁾	SOTDMA ITDMA	M
10	UTC/date inquiry	Request UTC and date	3	RATDMA, FATDMA, ITDMA ⁽²⁾	N/A	M/B
11	UTC/date response	Current UTC and date if available	3	RATDMA, ITDMA ⁽²⁾	SOTDMA	M
12	Addressed safety related message	Safety related data for addressed communication	2	RATDMA ⁽¹⁰⁾ , FATDMA, ITDMA ⁽²⁾	N/A	M/B
13	Safety related acknowledgement	Acknowledgement of received addressed safety related message	1	RATDMA, FATDMA, ITDMA ⁽²⁾	N/A	M/B
14	Safety related broadcast message	Safety related data for broadcast communication	2	RATDMA ⁽¹⁰⁾ , FATDMA, ITDMA ⁽²⁾	N/A	M/B
15	Interrogation	Request for a specific message type (can result in multiple responses from one or several stations) ⁽⁴⁾	3	RATDMA, FATDMA, ITDMA ⁽²⁾	N/A	M/B
16	Assignment mode command	Assignment of a specific report behaviour by competent authority using a Base station	1	RATDMA, FATDMA ⁽²⁾	N/A	B
17	DGNSS broadcast binary message	DGNSS corrections provided by a base station	2	FATDMA ⁽³⁾ , RATDMA ⁽²⁾	N/A	B

TABLE 43 (end)

Message ID	Name	Description	Priority	Access scheme	Communication state	M/B
18	Standard Class B equipment position report	Standard position report for Class B shipborne mobile equipment to be used instead of Messages 1, 2, 3 ⁽⁸⁾	1	SOTDMA, ITDMA ⁽¹⁾ , CSTDMA	SOTDMA, ITDMA	M
19	Extended Class B equipment position report	Extended position report for class B shipborne mobile equipment; contains additional static information ⁽⁸⁾	1	ITDMA	N/A	M
20	Data link management message	Reserve slots for Base station(s)	1	FATDMA ⁽³⁾ , RATDMA	N/A	B
21	Aids-to-navigation report	Position and status report for aids-to-navigation	1	FATDMA ⁽³⁾ , RATDMA ⁽²⁾	N/A	M/B
22	Channel management ⁽⁶⁾	Management of channels and transceiver modes by a Base station	1	FATDMA ⁽³⁾ , RATDMA ⁽²⁾	N/A	B
23	Group assignment command	Assignment of a specific report behaviour by competent authority using a Base station to a specific group of mobiles	1	FATDMA, RATDMA	N/A	B
24	Static data report	Additional data assigned to an MMSI Part A: Name Part B: Static Data	4	RATDMA, ITDMA, CSTDMA, FATDMA	N/A	M/B
25	Single slot binary message	Short unscheduled binary data transmission (Broadcast or addressed)	4	RATDMA, ITDMA, CSTDMA, FATDMA	N/A	M/B
26	Multiple slot binary message with Communications State	Scheduled binary data transmission (Broadcast or addressed)	4	SOTDMA, RATDMA, ITDMA	SOTDMA, ITDMA	M/B
27	Position report for long-range applications	Scheduled position report; (Class A shipborne mobile equipment outside base station coverage)	1	RATDMA	N/A	M

Notes relating to Table 43:

DGNSS: digital global navigation satellite system.

- (1) ITDMA is used during the first frame phase (see § 3.3.5.3, Annex 2) and during a change of Rr. SOTDMA is used during the continuous operation phase (see § 3.3.5.4, Annex 2). RATDMA can be used at any time to transmit additional position reports.
- (2) This message type should be broadcast within 4 s. The RATDMA access scheme is the default method (see § 3.3.4.2.1, Annex 2) for allocating the slot(s) for this message type. Alternatively, an existing SOTDMA allocated slot should, when possible, use the ITDMA access scheme for allocating the slot(s) for this message (this statement applies to mobiles only). A base station may use an existing FATDMA allocated slot for allocating the slot(s) for transmission of this message type.
- (3) A base station is always operating in assigned mode using a fixed transmission schedule (FATDMA) for its periodic transmissions. The data link management message should be used to announce the Base station's fixed allocation schedule (see Message 20). If necessary RATDMA may be used to transmit non-periodic broadcasts.
- (4) For interrogation of UTC and date, message identifier 10 should be used.
- (5) Priority 3, if in response to interrogation.
- (6) In order to satisfy the requirements for dual channel operation (see § 0, Annex 2 and § 4.1, Annex 2), the following should apply, unless otherwise specified by Message 22:
 - For periodic repeated messages, including the initial link access, the transmissions should alternate between AIS 1 and AIS 2.
 - Transmissions following slot allocation announcements, responses to interrogations, responses to requests, and acknowledgements should be transmitted on the same channel as the initial message.
 - For addressed messages, transmissions should utilize the channel in which a message from the addressed station was last received.
 - For non-periodic messages other than those referenced above, the transmissions of each message, regardless of message type, should alternate between AIS 1 and AIS 2.
- (7) Recommendations for base stations (dual channel operations): base stations should alternate their transmissions between AIS 1 and AIS 2 for the following reasons:
 - to increase link capacity;
 - to balance channel loading between AIS 1 and AIS 2; and
 - to mitigate the harmful effects of RF interference.
- (8) Equipment other than Class B shipborne mobile should not transmit Messages 18 and 19. Class B shipborne mobile equipment should only use Messages 18 and 19 for position reporting and static data.
- (9) When using reporting rate assignment by Message 16 the Access Scheme should be SOTDMA. When using assignment of transmission slots by Message 16 the Access Scheme should be assigned operation (see § 3.3.6.2, Annex 2) using SOTDMA communication state.
- (10) For Messages 6, 8, 12 and 14 RATDMA transmissions from a mobile station should not exceed a total of 20 slots in a frame with a maximum of 5 consecutive slots per message (see § 5.2.1, Annex 2).

3 Message descriptions

All positions should be to be transmitted in WGS 84 datum.

Some telegrams specify the inclusion of character data, such as ship's name, destination, call sign, and more. These fields should use a 6-bit ASCII as defined in Table 44.

TABLE 44

6-Bit ASCII				Standard ASCII			6-Bit ASCII				Standard ASCII		
Chr	Dec	Hex	Binary	Dec	Hex	Binary	Chr	Dec	Hex	Binary	Dec	Hex	Binary
@	0	0x00	00 0000	64	0x40	0100 0000	!	33	0x21	10 0001	33	0x21	0010 0001
A	1	0x01	00 0001	65	0x41	0100 0001	”	34	0x22	10 0010	34	0x22	0010 0010
B	2	0x02	00 0010	66	0x42	0100 0010	#	35	0x23	10 0011	35	0x23	0010 0011
C	3	0x03	00 0011	67	0x43	0100 0011	\$	36	0x24	10 0100	36	0x24	0010 0100
D	4	0x04	00 0100	68	0x44	0100 0100	%	37	0x25	10 0101	37	0x25	0010 0101
E	5	0x05	00 0101	69	0x45	0100 0101	&	38	0x26	10 0110	38	0x26	0010 0110
F	6	0x06	00 0110	70	0x46	0100 0110	`	39	0x27	10 0111	39	0x27	0010 0111
G	7	0x07	00 0111	71	0x47	0100 0111	(40	0x28	10 1000	40	0x28	0010 1000
H	8	0x08	00 1000	72	0x48	0100 1000)	41	0x29	10 1001	41	0x29	0010 1001
I	9	0x09	00 1001	73	0x49	0100 1001	*	42	0x2A	10 1010	42	0x2A	0010 1010
J	10	0x0A	00 1010	74	0x4A	0100 1010	.+	43	0x2B	10 1011	43	0x2B	0010 1011
K	11	0x0B	00 1011	75	0x4B	0100 1011	,	44	0x2C	10 1100	44	0x2C	0010 1100
L	12	0x0C	00 1100	76	0x4C	0100 1100	-	45	0x2D	10 1101	45	0x2D	0010 1101
M	13	0x0D	00 1101	77	0x4D	0100 1101	.	46	0x2E	10 1110	46	0x2E	0010 1110
N	14	0x0E	00 1110	78	0x4E	0100 1110	/	47	0x2F	10 1111	47	0x2F	0010 1111
O	15	0x0F	00 1111	79	0x4F	0100 1111	0	48	0x30	11 0000	48	0x30	0011 0000
P	16	0x10	01 0000	80	0x50	0101 0000	1	49	0x31	11 0001	49	0x31	0011 0001
Q	17	0x11	01 0001	81	0x51	0101 0001	2	50	0x32	11 0010	50	0x32	0011 0010
R	18	0x12	01 0010	82	0x52	0101 0010	3	51	0x33	11 0011	51	0x33	0011 0011
S	19	0x13	01 0011	83	0x53	0101 0011	4	52	0x34	11 0100	52	0x34	0011 0100
T	20	0x14	01 0100	84	0x54	0101 0100	5	53	0x35	11 0101	53	0x35	0011 0101
U	21	0x15	01 0101	85	0x55	0101 0101	6	54	0x36	11 0110	54	0x36	0011 0110
V	22	0x16	01 0110	86	0x56	0101 0110	7	55	0x37	11 0111	55	0x37	0011 0111
W	23	0x17	01 0111	87	0x57	0101 0111	8	56	0x38	11 1000	56	0x38	0011 1000
X	24	0x18	01 1000	88	0x58	0101 1000	9	57	0x39	11 1001	57	0x39	0011 1001
Y	25	0x19	01 1001	89	0x59	0101 1001	:	58	0x3A	11 1010	58	0x3A	0011 1010
Z	26	0x1A	01 1010	90	0x5A	0101 1010	;	59	0x3B	11 1011	59	0x3B	0011 1011
[27	0x1B	01 1011	91	0x5B	0101 1011	<	60	0x3C	11 1100	60	0x3C	0011 1100
\	28	0x1C	01 1100	92	0x5C	0101 1100	=	61	0x3D	11 1101	61	0x3D	0011 1101
]	29	0x1D	01 1101	93	0x5D	0101 1101	>	62	0x3E	11 1110	62	0x3E	0011 1110
^	30	0x1E	01 1110	94	0x5E	0101 1110	?	63	0x3F	11 1111	63	0x3F	0011 1111
-	31	0x1F	01 1111	95	0x5F	0101 1111							
Space	32	0x20	10 0000	32	0x20	0010 0000							

Unless otherwise specified all fields are binary. All numbers expressed are in decimal notation. Negative numbers are expressed using 2's complement.

3.1 Messages 1, 2, 3: Position reports

The position report should be output periodically by mobile stations.

TABLE 45

Parameter	Number of bits	Description
Message ID	6	Identifier for this Message 1, 2 or 3
Repeat indicator	2	Used by the repeater to indicate how many times a message has been repeated. See § 4.6.1, Annex 2; 0-3; 0 = default; 3 = do not repeat any more
User ID	30	Unique identifier such as MMSI number
Navigational status	4	0 = under way using engine, 1 = at anchor, 2 = not under command, 3 = restricted manoeuvrability, 4 = constrained by her draught, 5 = moored, 6 = aground, 7 = engaged in fishing, 8 = under way sailing, 9 = reserved for future amendment of navigational status for ships carrying DG, HS, or MP, or IMO hazard or pollutant category C, high speed craft (HSC), 10 = reserved for future amendment of navigational status for ships carrying dangerous goods (DG), harmful substances (HS) or marine pollutants (MP), or IMO hazard or pollutant category A, wing in grand (WIG); 11-13 = reserved for future use, 14 = AIS-SART (active), 15 = not defined = default (also used by AIS-SART under test)
Rate of turn ROT _{AIS}	8	0 to +126 = turning right at up to 708° per min or higher 0 to -126 = turning left at up to 708° per min or higher Values between 0 and 708° per min coded by $ROT_{AIS} = 4.733 \text{ SQRT}(ROT_{sensor})$ degrees per min where ROT _{sensor} is the Rate of Turn as input by an external Rate of Turn Indicator (TI). ROT _{AIS} is rounded to the nearest integer value. +127 = turning right at more than 5° per 30 s (No TI available) -127 = turning left at more than 5° per 30 s (No TI available) -128 (80 hex) indicates no turn information available (default). ROT data should not be derived from COG information.
SOG	10	Speed over ground in 1/10 knot steps (0-102.2 knots) 1 023 = not available, 1 022 = 102.2 knots or higher
Position accuracy	1	The position accuracy (PA) flag should be determined in accordance with Table 47 1 = high (≤10 m) 0 = low (>10 m) 0 = default
Longitude	28	Longitude in 1/10 000 min (±180°, East = positive (as per 2's complement), West = negative (as per 2's complement). 181 = (6791AC0 _h) = not available = default

TABLE 45 (*end*)

Parameter	Number of bits	Description
Latitude	27	Latitude in 1/10 000 min ($\pm 90^\circ$, North = positive (as per 2's complement), South = negative (as per 2's complement). 91° (3412140h) = not available = default)
COG	12	Course over ground in 1/10 = (0-3599). 3600 (E10 _h) = not available = default. 3 601-4 095 should not be used
True heading	9	Degrees (0-359) (511 indicates not available = default)
Time stamp	6	UTC second when the report was generated by the electronic position system (EPFS) (0-59, or 60 if time stamp is not available, which should also be the default value, or 61 if positioning system is in manual input mode, or 62 if electronic position fixing system operates in estimated (dead reckoning) mode, or 63 if the positioning system is inoperative)
special manoeuvre indicator	2	0 = not available = default 1 = not engaged in special manoeuvre 2 = engaged in special manoeuvre (i.e.: regional passing arrangement on Inland Waterway)
Spare	3	Not used. Should be set to zero. Reserved for future use.
RAIM-flag	1	Receiver autonomous integrity monitoring (RAIM) flag of electronic position fixing device; 0 = RAIM not in use = default; 1 = RAIM in use. See Table 47
Communication state	19	See Table 46
Number of bits	168	

TABLE 46

Message ID	Communication state
1	SOTDMA communication state as described in § 3.3.7.2.1, Annex 2
2	SOTDMA communication state as described in § 3.3.7.2.1, Annex 2
3	ITDMA communication state as described in § 3.3.7.3.2, Annex 2

TABLE 47

Determination of position accuracy information

Accuracy status from RAIM (for 95% of position fixes) ⁽¹⁾	RAIM flag	Differential correction status ⁽²⁾	Resulting value of PA flag
No RAIM process available	0	Uncorrected	0 = low (>10 m)
EXPECTED RAIM error is < 10m	1		1 = high (<10 m)
EXPECTED RAIM error is > 10m	1		0 = low (>10 m)
No RAIM process available	0	Corrected	1 = high (<10 m)
EXPECTED RAIM error is < 10m	1		1 = high (<10 m)
EXPECTED RAIM error is > 10m	1		0 = low (>10 m)

⁽¹⁾ The connected GNSS receiver indicates the availability of a RAIM process by a valid GBS sentence of IEC 61162-1; in this case the RAIM-flag should be set to "1". The threshold for evaluation of the RAIM information is 10 m. The RAIM expected error is calculated based on the GBS parameters "expected error in latitude" and "expected error in longitude" using the following formula:

$$\text{EXPECTED RAIM error} = \sqrt{(\text{expected error in latitude})^2 + (\text{expected error in longitude})^2}$$

⁽²⁾ The quality indicator in the position sentences of IEC 61162-1 received from the connected GNSS receiver indicates the correction status.

3.2 Message 4: Base station report**Message 11: UTC and date response**

Should be used for reporting UTC time and date and, at the same time, position. A base station should use Message 4 in its periodical transmissions. A mobile station should output Message 11 only in response to interrogation by Message 10.

Message 11 is only transmitted as a result of a UTC request message (Message 10). The UTC and date response should be transmitted on the channel, where the UTC request message was received.

TABLE 48

Parameter	Number of bits	Description
Message ID	6	Identifier for this Message 4 or 11 4 = UTC and position report from base station 11 = UTC and position response from mobile station
Repeat indicator	2	Used by the repeater to indicate how many times a message has been repeated. Refer to § 4.6.1, Annex 2; 0-3; 0 = default; 3 = do not repeat any more
User ID	30	MMSI number
UTC year	14	1-9999; 0 = UTC year not available = default
UTC month	4	1-12; 0 = UTC month not available = default; 13-15 not used
UTC day	5	1-31; 0 = UTC day not available = default
UTC hour	5	0-23; 24 = UTC hour not available = default; 25-31 not used

TABLE 48 (end)

Parameter	Number of bits	Description
UTC minute	6	0-59; 60 = UTC minute not available = default; 61-63 not used
UTC second	6	0-59; 60 = UTC second not available = default; 61-63 not used
Position accuracy	1	1 = high (≤ 10 m) 0 = low (> 10 m) 0 = default The PA flag should be determined in accordance with Table 47
Longitude	28	Longitude in 1/10 000 min ($\pm 180^\circ$, East = positive (as per 2's complement), West = negative (as per 2's complement); 181 = (6791AC0 _h) = not available = default)
Latitude	27	Latitude in 1/10 000 min ($\pm 90^\circ$, North = positive (as per 2's complement), South = negative (as per 2's complement); 91 = (3412140 _h) = not available = default)
Type of electronic position fixing device	4	Use of differential corrections is defined by field position accuracy above: 0 = undefined (default) 1 = global positioning system (GPS) 2 = GNSS (GLONASS) 3 = combined GPS/GLONASS 4 = Loran-C 5 = Chayka 6 = integrated navigation system 7 = surveyed 8 = Galileo 9-14 = not used 15 = internal GNSS
Transmission control for long-range broadcast message	1	0 = default – Class-A AIS station stops transmission of Message 27 within an AIS base station coverage area. 1 = Request Class-A station to transmit Message 27 within an AIS base station coverage area.
Spare	9	Not used. Should be set to zero. Reserved for future use
RAIM-flag	1	RAIM (Receiver autonomous integrity monitoring) flag of electronic position fixing device; 0 = RAIM not in use = default; 1 = RAIM in use see Table 47
Communication state	19	SOTDMA communication state as described in § 3.3.7.2.1, Annex 2
Number of bits	168	

3.3 Message 5: Ship static and voyage related data

Should only be used by Class A shipborne and SAR aircraft AIS stations when reporting static or voyage related data.

TABLE 49

Parameter	Number of bits	Description
Message ID	6	Identifier for this Message 5
Repeat indicator	2	Used by the repeater to indicate how many times a message has been repeated. Refer to § 4.6.1, Annex 2; 0-3; 0 = default; 3 = do not repeat any more
User ID	30	MMSI number
AIS version indicator	2	0 = station compliant with Recommendation ITU-R M.1371-1 1 = station compliant with Recommendation ITU-R M.1371-3 2-3 = station compliant with future editions
IMO number	30	1-999999999; 0 = not available = default – Not applicable to SAR aircraft
Call sign	42	7 = 6 bit ASCII characters, @@@@@@@@ = not available = default
Name	120	Maximum 20 characters 6 bit ASCII, as defined in Table 44 “@@@@@@@@@@@@@@@@@@@@@@@@@@@@@@@@” = not available = default. For SAR aircraft, it should be set to “SAR AIRCRAFT NNNNNNN” where NNNNNNN equals the aircraft registration number
Type of ship and cargo type	8	0 = not available or no ship = default 1-99 = as defined in § 3.3.2 100-199 = reserved, for regional use 200-255 = reserved, for future use Not applicable to SAR aircraft
Overall dimension/reference for position	30	Reference point for reported position. Also indicates the dimension of ship (m) (see Fig. 42 and § 3.3.3) For SAR aircraft, the use of this field may be decided by the responsible administration. If used it should indicate the maximum dimensions of the craft. As default should A = B = C = D be set to “0”
Type of electronic position fixing device	4	0 = undefined (default) 1 = GPS 2 = GLONASS 3 = combined GPS/GLONASS 4 = Loran-C 5 = Chayka 6 = integrated navigation system 7 = surveyed 8 = Galileo, 9-14 = not used 15 = internal GNSS

TABLE 49 (*end*)

Parameter	Number of bits	Description
ETA	20	Estimated time of arrival; MMDDHHMM UTC Bits 19-16: month; 1-12; 0 = not available = default Bits 15-11: day; 1-31; 0 = not available = default Bits 10-6: hour; 0-23; 24 = not available = default Bits 5-0: minute; 0-59; 60 = not available = default For SAR aircraft, the use of this field may be decided by the responsible administration
Maximum present static draught	8	In 1/10 m, 255 = draught 25.5 m or greater, 0 = not available = default; in accordance with IMO Resolution A.851 Not applicable to SAR aircraft, should be set to 0
Destination	120	Maximum 20 characters using 6-bit ASCII; @@@@@@@@@@@@@@@@@@@@ = not available For SAR aircraft, the use of this field may be decided by the responsible administration
DTE	1	Data terminal equipment (DTE) ready (0 = available, 1 = not available = default) (see § 3.3.1)
Spare	1	Spare. Not used. Should be set to zero. Reserved for future use
Number of bits	424	Occupies 2 slots

This message should be transmitted immediately after any parameter value has been changed.

3.3.1 The data terminal equipment indicator

The purpose of the data terminal equipment (DTE) indicator is to indicate to an application on the receiving side that, if set to available, the transmitting station conforms at least to the minimum keyboard and display requirements. On the transmitting side, the DTE indicator may also be set by an external application via the Presentation Interface. On the receiving side, the DTE indicator is only used as information provided to the application layer, that the transmitting station is available for communications.

3.3.2 Type of ship

TABLE 50

Identifiers to be used by ships to report their type	
Identifier No.	Special craft
50	Pilot vessel
51	Search and rescue vessels
52	Tugs
53	Port tenders
54	Vessels with anti-pollution facilities or equipment
55	Law enforcement vessels
56	Spare – for assignments to local vessels
57	Spare – for assignments to local vessels

TABLE 50 (*end*)

Identifiers to be used by ships to report their type			
Identifier No.	Special craft		
58	Medical transports (as defined in the 1949 Geneva Conventions and Additional Protocols)		
59	Ships and aircraft of States not parties to an armed conflict		
Other ships			
First digit⁽¹⁾	Second digit⁽¹⁾	First digit⁽¹⁾	Second digit⁽¹⁾
1 – Reserved for future use	0 – All ships of this type	–	0 – Fishing
2 – WIG	1 – Carrying DG, HS, or MP, IMO hazard or pollutant category X ⁽²⁾	–	1 – Towing
3 – See right column	2 – Carrying DG, HS, or MP, IMO hazard or pollutant category Y ⁽²⁾	3 – Vessel	2 – Towing and length of the tow exceeds 200 m or breadth exceeds 25 m
4 – HSC	3 – Carrying DG, HS, or MP, IMO hazard or pollutant category Z ⁽²⁾	–	3 – Engaged in dredging or underwater operations
5 – See above	4 – Carrying DG, HS, or MP, IMO hazard or pollutant category OS ⁽²⁾	–	4 – Engaged in diving operations
	5 – Reserved for future use	–	5 – Engaged in military operations
6 – Passenger ships	6 – Reserved for future use	–	6 – Sailing
7 – Cargo ships	7 – Reserved for future use	–	7 – Pleasure craft
8 – Tanker(s)	8 – Reserved for future use	–	8 – Reserved for future use
9 – Other types of ship	9 – No additional information	–	9 – Reserved for future use

DG: dangerous goods

HS: harmful substances

MP: marine pollutants

⁽¹⁾ The identifier should be constructed by selecting the appropriate first and second digits.

⁽²⁾ NOTE 1 – The digits 1, 2, 3 and 4 reflecting categories X, Y, Z and OS formerly were categories A, B, C and D.

3.3.3 Reference point for reported position and overall dimensions of ship

FIGURE 41

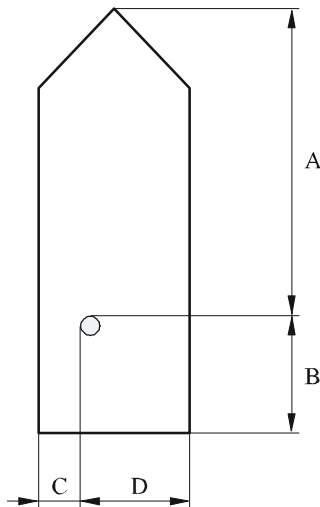

	Number of bits	Bit fields	Distance (m)
A	9	Bit 21-Bit 29	0-511 511 = 511 m or greater
B	9	Bit 12-Bit 20	0-511 511 = 511 m or greater
C	6	Bit 6-Bit 11	0-63; 63 = 63 m or greater
D	6	Bit 0-Bit 5	0-63; 63 = 63 m or greater

The dimension A should be in the direction of the transmitted heading information (bow)
 Reference point of reported position not available, but dimensions of ship are available: A = C = 0 and B ≠ 0 and D ≠ 0.
 Neither reference point of reported position nor dimensions of ship available; A = B = C = D = 0 (= default).
 For use in the message table, A = most significant field,
 D = least significant field.

1371-41

3.4 Message 6: Addressed binary message

The addressed binary message should be variable in length, based on the amount of binary data. The length should vary between 1 and 5 slots. See application identifiers in § 2.1, Annex 5.

TABLE 51

Parameter	Number of bits	Description		
Message ID	6	Identifier for Message 6; always 6		
Repeat indicator	2	Used by the repeater to indicate how many times a message has been repeated. Refer to § 4.6.1, Annex 2; 0-3; default = 0; 3 = do not repeat any more		
Source ID	30	MMSI number of source station		
Sequence number	2	0-3; refer to § 5.3.1, Annex 2		
Destination ID	30	MMSI number of destination station		
Retransmit flag	1	Retransmit flag should be set upon retransmission: 0 = no retransmission = default; 1 = retransmitted		
Spare	1	Not used. Should be zero. Reserved for future use		
Binary data	Maximum 936	Application identifier	16 bits	Should be as described in § 2.1, Annex 5
		Application data	Maximum 920 bits	Application specific data
Maximum number of bits	Maximum 1 008	Occupies 1 to 5 slots subject to the length of sub-field message content. For Class B mobile AIS stations the length of the message should not exceed 2 slots		

Additional bit stuffing will be required for these message types. For details refer to transport layer, § 5.2.1, Annex 2.

Table 52 gives the number of binary data bytes (including application ID and application data), so that the whole message fits into a given number of slots. It is recommended that any application minimizes the use of slots by limiting the number of binary data bytes to the numbers given, if possible:

TABLE 52

Number of slots	Maximum binary data bytes
1	8
2	36
3	64
4	92
5	117

These numbers also take bit stuffing into account.

3.5 Message 7: Binary acknowledge

Message 13: Safety related acknowledge

Message 7 should be used as an acknowledgement of up to four Message 6 messages received (see § 5.3.1, Annex 2) and should be transmitted on the channel, where the addressed message to be acknowledged was received.

Message 13 should be used as an acknowledgement of up to four Message 12 messages received (see § 5.3.1, Annex 2) and should be transmitted on the channel, where the addressed message to be acknowledged was received.

These acknowledgements should be applicable only to the VHF data link (see § 5.3.1, Annex 2). Other means must be employed for acknowledging applications.

TABLE 53

Parameter	Number of bits	Description
Message ID	6	Identifier for Messages 7 or 13 7 = binary acknowledge 13 = safety related acknowledge
Repeat indicator	2	Used by the repeater to indicate how many times a message has been repeated. See § 4.6.1, Annex 2; 0-3; 0 = default; 3 = do not repeat any more
Source ID	30	MMSI number of source of this acknowledge (ACK)
Spare	2	Not used. Should be set to zero. Reserved for future use
Destination ID1	30	MMSI number of first destination of this ACK
Sequence number for ID1	2	Sequence number of message to be acknowledged; 0-3

TABLE 53 (*end*)

Parameter	Number of bits	Description
Destination ID2	30	MMSI number of second destination of this ACK; should be omitted if no destination ID2
Sequence number for ID2	2	Sequence number of message to be acknowledged; 0-3; should be omitted if no destination ID2
Destination ID3	30	MMSI number of third destination of this ACK; should be omitted if no destination ID3
Sequence number for ID3	2	Sequence number of message to be acknowledged; 0-3; should be omitted if no destination ID3
Destination ID4	30	MMSI number of fourth destination of this ACK; should be omitted if no destination ID4
Sequence number for ID4	2	Sequence number of message to be acknowledged; 0-3. Should be omitted if there is no destination ID4
Number of bits	72-168	

3.6 Message 8: Binary broadcast message

This message will be variable in length, based on the amount of binary data. The length should vary between 1 and 5 slots.

TABLE 54

Parameter	Number of bits	Description		
Message ID	6	Identifier for Message 8; always 8		
Repeat indicator	2	Used by the repeater to indicate how many times a message has been repeated. See § 4.6.1, Annex 2; 0-3; default = 0; 3 = do not repeat any more		
Source ID	30	MMSI number of source station		
Spare	2	Not used. Should be set to zero. Reserved for future use		
Binary data	Maximum 968	Application identifier	16 bits	Should be as described in § 2.1, Annex 5
		Application data	Maximum 952 bits	Application specific data
Maximum number of bits	Maximum 1 008	Occupies 1 to 5 slots For Class B mobile AIS stations the length of the message should not exceed 2 slots		

Table 55 gives the number of binary data bytes (including application ID and application data), so that the whole message fits into a given number of slots. It is recommended that any application minimizes the use of slots by limiting the number of binary data bytes to the numbers given, if possible:

TABLE 55

Number of slots	Maximum binary data bytes
1	12
2	40
3	68
4	96
5	121

These numbers also take into account bit stuffing.

Additional bit stuffing will be required for this message type. For details refer to transport layer, § 5.2.1, Annex 2.

3.7 Message 9: Standard SAR aircraft position report

This message should be used as a standard position report for aircraft involved in SAR operations. Stations other than aircraft involved in SAR operations should not transmit this message. The default reporting interval for this message should be 10 s.

TABLE 56

Parameter	Number of bits	Description
Message ID	6	Identifier for Message 9; always 9
Repeat indicator	2	Used by the repeater to indicate how many times a message has been repeated. See § 4.6.1, Annex 2; 0-3; 0 = default; 3 = do not repeat any more
User ID	30	MMSI number
Altitude (GNSS)	12	Altitude (derived from GNSS or barometric (see altitude sensor parameter below)) (m) (0-4 094 m) 4 095 = not available, 4 094 = 4 094 m or higher
SOG	10	Speed over ground in knot steps (0-1 022 knots) 1 023 = not available, 1 022 = 1 022 knots or higher
Position accuracy	1	1 = high (≤ 10 m) 0 = low (> 10 m) 0 = default The PA flag should be determined in accordance with Table 47
Longitude	28	Longitude in 1/10 000 min ($\pm 180^\circ$, East = positive (as per 2's complement), West = negative (as per 2's complement); 181 = (6791AC0h) = not available = default)
Latitude	27	Latitude in 1/10 000 min ($\pm 90^\circ$, North = positive (as per 2's complement), South = negative (as per 2's complement); 91 = (3412140h) = not available = default)

TABLE 56 (*end*)

Parameter	Number of bits	Description
COG	12	Course over ground in 1/10 = (0-3 599). 3 600 (E10 _h) = not available = default; 3 601-4 095 should not be used
Time stamp	6	UTC second when the report was generated by the EPFS (0-59 or 60 if time stamp is not available, which should also be the default value or 61 if positioning system is in manual input mode or 62 if electronic position fixing system operates in estimated (dead reckoning) mode or 63 if the positioning system is inoperative)
Altitude sensor	1	0 = GNSS 1 = barometric source
Spare	7	Not used. Should be set to zero. Reserved for future use
DTE	1	Data terminal ready (0 = available 1 = not available = default) (see § 3.3.1)
Spare	3	Not used. Should be set to zero. Reserved for future use
Assigned mode flag	1	0 = Station operating in autonomous and continuous mode = default 1 = Station operating in assigned mode
RAIM-flag	1	RAIM flag of electronic position fixing device; 0 = RAIM not in use = default; 1 = RAIM in use see Table 47
Communication state selector flag	1	0 = SOTDMA communication state follows 1 = ITDMA communication state follows
Communication state	19	SOTDMA communication state (see § 3.3.7.2.1, Annex 2), if communication state selector flag is set to 0, or ITDMA communication state (see § 3.3.7.3.2, Annex 2), if communication state selector flag is set to 1
Number of bits	168	

3.8 Message 10: UTC and date inquiry

This message should be used when a station is requesting UTC and date from another station.

TABLE 57

Parameter	Number of bits	Description
Message ID	6	Identifier for Message 10; always 10
Repeat indicator	2	Used by the repeater to indicate how many times a message has been repeated. See § 4.6.1, Annex 2; 0-3; 0 = default; 3 = do not repeat any more
Source ID	30	MMSI number of station which inquires UTC
Spare	2	Not used. Should be set to zero. Reserved for future use
Destination ID	30	MMSI number of station which is inquired
Spare	2	Not used. Should be set to zero. Reserved for future use
Number of bits	72	

3.9 Message 11: UTC/date response

For Message 11 refer to description of Message 4.

3.10 Message 12: Addressed safety related message

The addressed safety related message could be variable in length, based on the amount of safety related text. The length should vary between 1 and 5 slots.

TABLE 58

Parameter	Number of bits	Description
Message ID	6	Identifier for Message 12; always 12
Repeat indicator	2	Used by the repeater to indicate how many times a message has been repeated. See § 4.6.1, Annex 2; 0-3; 0 = default; 3 = do not repeat any more
Source ID	30	MMSI number of station which is the source of the message.
Sequence number	2	0-3; see § 5.3.1, Annex 2
Destination ID	30	MMSI number of station which is the destination of the message
Retransmit flag	1	Retransmit flag should be set upon retransmission: 0 = no retransmission = default; 1 = retransmitted
Spare	1	Not used. Should be zero. Reserved for future use
Safety related text	Maximum 936	6-bit ASCII as defined in Table 44
Maximum number of bits	Maximum 1 008	Occupies 1 to 5 slots subject to the length of text For Class B mobile AIS stations the length of the message should not exceed 2 slots

Additional bit stuffing will be required for this message type. For details refer to transport layer, § 5.2.1, Annex 2.

Table 59 gives the number of 6-bit-ASCII characters, so that the whole message fits into a given number of slots. It is recommended that any application minimizes the use of slots by limiting the number of characters to the numbers given, if possible:

TABLE 59

Number of slots	Maximum 6-bit ASCII characters
1	10
2	48
3	85
4	122
5	156

These numbers also take bit stuffing into account.

3.11 Message 13: Safety related acknowledge

For Message 13 refer to description of Message 7.

3.12 Message 14: Safety related broadcast message

The safety related broadcast message could be variable in length, based on the amount of safety related text. The length should vary between 1 and 5 slots.

TABLE 60

Parameter	Number of bits	Description
Message ID	6	Identifier for Message 14; always 14.
Repeat indicator	2	Used by the repeater to indicate how many times a message has been repeated. See § 4.6.1, Annex 2; 0-3; 0 = default; 3 = do not repeat any more
Source ID	30	MMSI number of source station of message
Spare	2	Not used. Should be set to zero. Reserved for future use
Safety related text	Maximum 968	6-bit ASCII as defined in Table 44
Maximum number of bits	Maximum 1 008	Occupies 1 to 5 slots subject to the length of text. For Class B mobile AIS stations the length of the message should not exceed 2 slots

Additional bit stuffing will be required for this message type. For details refer to transport layer, § 5.2.1, Annex 2.

Table 61 gives the number of 6-bit ASCII characters, so that the whole message fits into a given number of slots. It is recommended that any application minimizes the use of slots by limiting the number of characters to the numbers given, if possible:

TABLE 61

Number of slots	Maximum 6-bit ASCII characters
1	16
2	53
3	90
4	128
5	161

These numbers also take bit stuffing into account.

The AIS-SART should use Message 14, and the safety related text should be:

- 1 For the active SART, the text should be "SART ACTIVE".
- 2 For the test mode, the text should be "SART TEST".

3.13 Message 15: Interrogation

This message should be used for interrogations via the TDMA (not DSC) VHF data link other than requests for UTC and date. The response should be transmitted on the channel where the interrogation was received.

TABLE 62

Interrogator	Class A	Class B-SO	Class B-CS	SAR aircraft	AtoN	Base station
Interrogated						
Class A	3, 5	N	N	3, 5	N	3, 5
Class B-SO	18, 19	N	N	18, 19	N	18, 19
Class B-CS	18, 24 ⁽¹⁾	N	N	18, 24 ⁽¹⁾	N	18, 19, 24 ⁽¹⁾
SAR-aircraft	9, 24 ⁽¹⁾	N	N	9	N	9, 24 ⁽¹⁾
AtoN	21	N	N	N	N	21
Base Station	4, 24 ⁽¹⁾	N	N	4, 24 ⁽¹⁾	N	4, 24 ⁽¹⁾

⁽¹⁾ An Interrogation for Message 24 shall be answered with a Part A and depending on its own capability with a Part B.

⁽²⁾ Some AtoN stations are not able to respond due to there operational behaviour.

The parameter slot offset should be set to zero, if slot should autonomously be allocated by the responding station. An interrogating mobile station should always set the parameter “slot offset” to zero. Slot assignments for the reply to an interrogation should only be used by a base station. If a slot offset is given, it should be relative to the start slot of this transmission. A mobile station should be able to process a minimum slot offset of 10 slots. There should be the following four (4) possibilities to use this message:

- One (1) station is interrogated one (1) message: The parameters destination ID1, message ID1.1 and slot offset 1.1 should be defined. All other parameters should be omitted.
- One (1) station is interrogated two (2) messages: The parameters destination ID1, message ID1.1, slot offset 1.1, message ID2.1, and slot offset 1.2 should be defined. The parameters destination ID2, message ID2.1, and slot offset 2.1 should be omitted. See § 3.3.7, Annex 2 for byte boundaries.
- The first station and the second station are interrogated one (1) message each: The parameters destination ID1, message ID1.1, slot offset 1.1, destination ID2, message ID2.1, and slot offset 2.1 should be defined. The parameters message ID1.2 and slot offset 1.2 should be set to zero (0).
- The first station is interrogated two (2) messages, and the second station is interrogated one (1) message: All parameters should be defined.

TABLE 63

Parameter	Number of bits	Description
Message ID	6	Identifier for Message 15; always set to 15
Repeat indicator	2	Used by the repeater to indicate how many times a message has been repeated. See § 4.6.1, Annex 2; 0-3; 0 = default; 3 = do not repeat any more
Source ID	30	MMSI number of interrogating station
Spare	2	Not used. Should be set to zero. Reserved for future use
Destination ID1	30	MMSI number of first interrogated station

TABLE 63 (*end*)

Parameter	Number of bits	Description
Message ID1.1	6	First requested message type from first interrogated station
Slot offset 1.1	12	Response slot offset for first requested message from first interrogated station
Spare	2	Not used. Should be set to zero. Reserved for future use
Message ID1.2	6	Second requested message type from first interrogated station
Slot offset 1.2	12	Response slot offset for second requested message from first interrogated station
Spare	2	Not used. Should be set to zero. Reserved for future use
Destination ID 2	30	MMSI number of second interrogated station
Message ID 2.1	6	Requested message type from second interrogated station
Slot offset 2.1	12	Response slot offset for requested message from second interrogated station
Spare	2	Not used. Should be set to zero. Reserved for future use
Number of bits	88-160	Total number of bits depends upon number of messages requested

3.14 Message 16: Assigned mode command

Assignment should be transmitted by a base station when operating as a controlling entity. Other stations can be assigned a transmission schedule, other than the currently used one. If a station is assigned a schedule, it will also enter assigned mode.

Two stations can be assigned simultaneously.

When receiving an assignment schedule, the station should tag it with a time-out, randomly selected between 4 and 8 min after the first transmission.

When a Class A shipborne mobile AIS station receives an assignment it should revert to either the assigned reporting rate or the resulting reporting rate (when slot assignment is used) or the autonomously derived reporting rate (see § 4.3.1, Annex 2), whatever is higher. The Class A shipborne mobile AIS station should indicate that it is in assigned mode (by using the appropriate messages), even if it reverts to a higher autonomously derived reporting rate.

NOTE 1 – The assigning station should monitor the mobile station's transmissions in order to determine when the mobile station will time-out.

For bounds of assignment settings see Table 16, Annex 2.

Transmissions of Message 16 by base stations using assignment of transmission slots should consider directing transmissions to slots which have previously been reserved by the base station by FATDMA (Message 20).

If continued assignment is required, the new assignment should be transmitted before the start of the last frame of the previous assignment.

TABLE 64

Parameter	Number of bits	Description
Message ID	6	Identifier for Message 16. Always 16
Repeat indicator	2	Used by the repeater to indicate how many times a message has been repeated. See § 4.6.1, Annex 2; 0-3; 0 = default; 3 = do not repeat any more
Source ID	30	MMSI of assigning station
Spare	2	Spare. Should be set to zero. Reserved for future use
Destination ID A	30	MMSI number. Destination identifier A
Offset A	12	Offset from current slot to first assigned slot ⁽¹⁾
Increment A	10	Increment to next assigned slot ⁽¹⁾
Destination ID B	30	MMSI number. Destination identifier B. Should be omitted if there is assignment to station A, only
Offset B	12	Offset from current slot to first assigned slot. Should be omitted if there is assignment to station A, only ⁽¹⁾
Increment B	10	Increment to next assigned slot ⁽¹⁾ . Should be omitted, if there is assignment to station A, only
Spare	Maximum 4	Spare. Not used. Should be set to zero. The number of spare bits, which should be 0 or 4, should be adjusted in order to observe byte boundaries. Reserved for future use
Number of bits	96 or 144	Should be 96 or 144 bits

⁽¹⁾ To assign a reporting rate for a station, the parameter increment should be set to zero. The parameter offset should then be interpreted as the number of reports in a time interval of 10 min.

When number of reports per 10 min are assigned, only multiples of 20 between 20 and 600 should be used. If a mobile station received a value which is not a multiple of 20 but below 600, it should use the next higher multiple of 20. If a mobile station receives a value greater than 600 it should use 600.

When slot increments are assigned, one of the following increment parameter settings should be used:

- 0 = see above
- 1 = 1125 slots
- 2 = 375 slots
- 3 = 225 slots
- 4 = 125 slots
- 5 = 75 slots
- 6 = 45 slots
- 7 = undefined.

If a station receives the value 7, the station should disregard this assignment. Class B mobile AIS stations should not be assigned a reporting interval of less than 2 s.

3.15 Message 17: GNSS broadcast binary message

This message should be transmitted by a base station, which is connected to a DGNSS reference source, and configured to provide DGNSS data to receiving stations. The contents of the data should be in accordance with Recommendation ITU-R M.823, excluding preamble and parity formatting.

TABLE 65

Parameter	Number of bits	Description
Message ID	6	Identifier for Message 17; always 17
Repeat indicator	2	Used by the repeater to indicate how many times a message has been repeated. See § 4.6.1, Annex 2; 0-3; 0 = default; 3 = do not repeat any more
Source ID	30	MMSI of the base station
Spare	2	Spare. Should be set to zero. Reserved for future use
Longitude	18	Surveyed longitude of DGNSS reference station in 1/10 min ($\pm 180^\circ$, East = positive, West = negative). If interrogated and differential correction service not available, the longitude should be set to 181°
Latitude	17	Surveyed latitude of DGNSS reference station in 1/10 min ($\pm 90^\circ$, North = positive, South = negative). If interrogated and differential correction service not available, the latitude should be set to 91°
Spare	5	Not used. Should be set to zero. Reserved for future use
Data	0-736	Differential correction data (see below). If interrogated and differential correction service not available, the data field should remain empty (zero bits). This should be interpreted by the recipient as DGNSS data words set to zero
Number of bits	80-816	80 bits: assumes $N = 0$; 816 bits: assumes $N = 29$ (maximum value); see Table 66

The differential correction data section should be organized as listed below:

TABLE 66

Parameter	Number of bits	Description
Message type	6	Recommendation ITU-R M.823
Station ID	10	Recommendation ITU-R M.823 station identifier
Z count	13	Time value in 0.6 s (0-3 599.4)
Sequence number	3	Message sequence number (cyclic 0-7)
N	5	Number of DGNSS data words following the two word header, up to a maximum of 29
Health	3	Reference station health (specified in Recommendation ITU-R M.823)

TABLE 66 (*end*)

Parameter	Number of bits	Description
DGNSS data word	N = 24	DGNSS message data words excluding parity
Number of bits	736	Assuming $N = 29$ (the maximum value)

NOTE 1 – It is necessary to restore preamble and parity in accordance with Recommendation ITU-R M.823 before using this message to differentially correct GNSS positions to DGNSS positions.

NOTE 2 – Where DGNSS corrections are received from multiple sources, the DGNSS corrections from the nearest DGNSS reference station should be used taking into account the Z count, and the health of the DGNSS reference station.

NOTE 3 – Transmissions of Message 17 by base stations should take into account ageing, update rate and the resulting accuracy of the DGNSS service. Because of the resulting effects of VDL channel loading, the transmission of Message 17 should be no more than necessary to provide the necessary DGNSS service accuracy.

3.16 Message 18: Standard Class B equipment position report

The Standard Class B equipment position report should be output periodically and autonomously instead of Messages 1, 2, or 3 by Class B shipborne mobile equipment, only. The reporting interval should default to the values given in Table 2, Annex 1, unless otherwise specified by reception of a Message 16 or 23; and depending on the current SOG and navigational status flag setting.

TABLE 67

Parameter	Number of bits	Description
Message ID	6	Identifier for Message 18; always 18
Repeat indicator	2	Used by the repeater to indicate how many times a message has been repeated. See § 4.6.1, Annex 2; 0-3; 0 = default; 3 = do not repeat any more; should be 0 for “CS” transmissions
User ID	30	MMSI number
Spare	8	Not used. Should be set to zero. Reserved for future use
SOG	10	Speed over ground in 1/10 knot steps (0-102.2 knots) 1 023 = not available, 1 022 = 102.2 knots or higher
Position accuracy	1	1 = high (≤ 10 m) 0 = low (> 10 m) 0 = default The PA flag should be determined in accordance with Table 47
Longitude	28	Longitude in 1/10 000 min ($\pm 180^\circ$, East = positive (as per 2's complement), West = negative (as per 2's complement); 181° (6791AC0h) = not available = default)
Latitude	27	Latitude in 1/10 000 min ($\pm 90^\circ$, North = positive (as per 2's complement), South = negative (as per 2's complement); 91° (3412140h) = not available = default)
COG	12	Course over ground in 1/10° (0-3 599). 3 600 (E10h) = not available = default; 3 601-4 095 should not be used

TABLE 67 (end)

Parameter	Number of bits	Description
True heading	9	Degrees (0-359) (511 indicates not available = default)
Time stamp	6	UTC second when the report was generated by the EPFS (0-59 or 60 if time stamp is not available, which should also be the default value or 61 if positioning system is in manual input mode or 62 if electronic position fixing system operates in estimated (dead reckoning) mode or 63 if the positioning system is inoperative) 61, 62, 63 are not used by "CS" AIS
Spare	2	Not used. Should be set to zero. Reserved for future use
Class B unit flag	1	0 = Class B SOTDMA unit 1 = Class B "CS" unit
Class B display flag	1	0 = No display available; not capable of displaying Message 12 and 14 1 = Equipped with integrated display displaying Message 12 and 14
Class B DSC flag	1	0 = Not equipped with DSC function 1 = Equipped with DSC function (dedicated or time-shared)
Class B band flag	1	0 = Capable of operating over the upper 525 kHz band of the marine band 1 = Capable of operating over the whole marine band (irrelevant if "Class B Message 22 flag" is 0)
Class B Message 22 flag	1	0 = No frequency management via Message 22, operating on AIS1, AIS2 only 1 = Frequency management via Message 22
Mode flag	1	0 = Station operating in autonomous and continuous mode = default 1 = Station operating in assigned mode
RAIM-flag	1	RAIM (Receiver autonomous integrity monitoring) flag of electronic position fixing device; 0 = RAIM not in use = default; 1 = RAIM in use see Table 47
Communication state selector flag	1	0 = SOTDMA communication state follows 1 = ITDMA communication state follows (always "1" for Class-B "CS")
Communication state	19	SOTDMA communication state (see § 3.3.7.2.1, Annex 2), if communication state selector flag is set to 0, or ITDMA communication state (see § 3.3.7.3.2, Annex 2), if communication state selector flag is set to 1 Because Class B "CS" does not use any Communication State information, this field should be filled with the following value: 1100000000000000110
Number of bits	168	Occupies one slot

3.17 Message 19: Extended Class B equipment position report

This message should be used by Class B shipborne mobile equipment. This message should be transmitted once every 6 min in two slots allocated by the use of Message 18 in the ITDMA communication state. This message should be transmitted immediately after the following parameter values change: dimension of ship/reference for position or type of electronic position fixing device.

TABLE 68

Parameter	Number of bits	Description
Message ID	6	Identifier for Message 19; always 19
Repeat indicator	2	Used by the repeater to indicate how many times a message has been repeated. See § 4.6.1, Annex 2; 0-3; 0 = default; 3 = do not repeat any more
User ID	30	MMSI number
Spare	8	Not used. Should be set to zero. Reserved for future use
SOG	10	Speed over ground in 1/10 knot steps (0-102.2 knots) 1 023 = not available, 1 022 = 102.2 knots or higher
Position accuracy	1	1 = high (≤ 10 m) 0 = low (> 10 m) 0 = default The PA flag should be determined in accordance with Table 47
Longitude	28	Longitude in 1/10 000 min ($\pm 180^\circ$, East = positive (as per 2's complement), West = negative (as per 2's complement); 181° (6791AC0h) = not available = default)
Latitude	27	Latitude in 1/10 000 min ($\pm 90^\circ$, North = positive (as per 2's complement), South = negative (as per 2's complement); 91 = (3412140h) = not available = default)
COG	12	Course over ground in 1/10° (0-3 599). 3 600 (E10h) = not available = default; 3 601-4 095 should not be used
True heading	9	Degrees (0-359) (511 indicates not available = default)
Time stamp	6	UTC second when the report was generated by the EPFS (0-59 or 60) if time stamp is not available, which should also be the default value or 61 if positioning system is in manual input mode or 62 if electronic position fixing system operates in estimated (dead reckoning) mode, or 63 if the positioning system is inoperative)
Spare	4	Not used. Should be set to zero. Reserved for future use
Name	120	Maximum 20 characters 6-bit ASCII, as defined in Table 44. @@@@@@@@@@@@@@@@@@@@@@@@@@@@@@@@ = not available = default
Type of ship and cargo type	8	0 = not available or no ship = default 1-99 = as defined in § 3.3.2 100-199 = reserved, for regional use 200-255 = reserved, for future use
Dimension of ship/reference for position	30	Dimensions of ship in metres and reference point for reported position (see Fig. 41 and § 3.3.3)
Type of electronic position fixing device	4	0 = Undefined (default); 1 = GPS, 2 = GLONASS, 3 = combined GPS/GLONASS, 4 = Loran-C, 5 = Chayka, 6 = integrated navigation system, 7 = surveyed; 8 = Galileo, 9-14 = not used, 15 = internal GNSS

TABLE 68 (*end*)

Parameter	Number of bits	Description
RAIM-flag	1	RAIM (Receiver autonomous integrity monitoring) flag of electronic position fixing device; 0 = RAIM not in use = default; 1 = RAIM in use see Table 47
DTE	1	Data terminal ready (0 = available 1 = not available; = default) (see § 3.3.1)
Assigned mode flag	1	0 = Station operating in autonomous and continuous mode = default 1 = Station operating in assigned mode
Spare	4	Not used. Should be set to zero. Reserved for future use
Number of bits	312	Occupies two slots

3.18 Message 20: Data link management message

This message should be used by base station(s) to pre-announce the fixed allocation schedule (FATDMA) for one or more base station(s) and it should be repeated as often as required. This way the system can provide a high level of integrity for base station(s). This is especially important in regions where several base stations are located adjacent to each other and mobile station(s) move between these different regions. These reserved slots cannot be autonomously allocated by mobile stations.

The mobile station, within 120 nautical miles¹³ should then reserve the slots for transmission by the base station(s) until time-out occurs. The base station should refresh the time-out value with each transmission of Message 20 in order to allow mobile stations to terminate their reservation for the use of the slots by the base stations (refer to § 3.3.1.2, Annex 2).

The parameters: offset number, number of slots, time-out, and increment should be treated as a unit, meaning that if one parameter is defined all other parameters should be defined within that unit. The parameter offset number should denote the offset from the slot in which Message 20 was received to the first slot to be reserved. The parameter number of slots should denote the number of consecutive slots to be reserved starting with the first reserved slot. This defines a reservation block. This reservation block should not exceed 5 slots. The parameter increment should denote the number of slots between the starting slot of each reservation block. An increment of zero indicates one reservation block per frame. The values recommended for increment are as follows: 2, 3, 5, 6, 9, 10, 15, 18, 25, 30, 45, 50, 75, 90, 125, 150, 225, 250, 375, 450, 750, or 1125. Use of one of these values guarantees symmetric slot reservations throughout each frame. This message applies only to the frequency channel in which it is transmitted.

If interrogated and no data link management information available, only offset number 1, number of slots 1, time-out 1, and increment 1 should be sent. These fields should all be set to zero.

¹³ A base station report (Message 4) in conjunction with a data link management message (Message 20) with the same base station ID (MMSI) must be received by the mobile station so that it can determine its distance from the transmitting base station.

TABLE 69

Parameter	Number of bits	Description
Message ID	6	Identifier for Message 20; always 20
Repeat indicator	2	Used by the repeater to indicate how many times a message has been repeated. See § 4.6.1, Annex 2; 0-3; 0 = default; 3 = do not repeat any more
Source station ID	30	MMSI number of base station
Spare	2	Not used. Should be set to zero. Reserved for future use
Offset number 1	12	Reserved offset number; 0 = not available ⁽¹⁾
Number of slots 1	4	Number of reserved consecutive slots: 1-15; 0 = not available ⁽¹⁾
Time-out 1	3	Time-out value in minutes; 0 = not available ⁽¹⁾
Increment 1	11	Increment to repeat reservation block 1; 0 = one reservation block per frame ⁽¹⁾
Offset number 2	12	Reserved offset number (optional)
Number of slots 2	4	Number of reserved consecutive slots: 1-15; optional
Time-out 2	3	Time-out value in minutes (optional)
Increment 2	11	Increment to repeat reservation block 2 (optional)
Offset number 3	12	Reserved offset number (optional)
Number of slots 3	4	Number of reserved consecutive slots: 1-15; optional
Time-out 3	3	Time-out value in minutes (optional)
Increment 3	11	Increment to repeat reservation block 3 (optional)
Offset number 4	12	Reserved offset number (optional)
Number of slots 4	4	Number of reserved consecutive slots: 1-15; optional
Time-out 4	3	Time-out value in minutes (optional)
Increment 4	11	Increment to repeat reservation block 4 (optional)
Spare	Maximum 6	Not used. Should be set to zero. The number of spare bits which may be 0, 2, 4 or 6 should be adjusted in order to observe byte boundaries. Reserved for future use
Number of bits	72-160	

⁽¹⁾ If interrogated and no data link management information is available, only Offset number 1, number of slots 1, time-out 1, and increment 1 should be sent. These fields should all be set to zero.

3.19 Message 21: Aids-to-navigation report (AtoN)

This message should be used by an AtoN AIS station. This station may be mounted on an aid-to-navigation or this message may be transmitted by a fixed station when the functionality of an AtoN station is integrated into the fixed station. This message should be transmitted autonomously

at a Rr of once every three (3) min or it may be assigned by an assigned mode command (Message 16) via the VHF data link, or by an external command. This message should not occupy more than two slots.

TABLE 70

Parameter	Number of bits	Description
Message ID	6	Identifier for Message 21
Repeat indicator	2	Used by the repeater to indicate how many times a message has been repeated. See § 4.6.1, Annex 2; 0-3; 0 = default; 3 = do not repeat any more
ID	30	MMSI number, (see Article 19 of the RR and Recommendation ITU-R M.585)
Type of aids-to-navigation	5	0 = not available = default; refer to appropriate definition set up by IALA; see Table 71
Name of Aids-to-Navigation	120	Maximum 20 characters 6-bit ASCII, as defined in Table 44 “@@@@@@@@@@@@@@@@@@@@” = not available = default. The name of the AtoN may be extended by the parameter “Name of Aid-to-Navigation Extension” below
Position accuracy	1	1 = high (≤ 10 m) 0 = low (> 10 m) 0 = default The PA flag should be determined in accordance with Table 47
Longitude	28	Longitude in 1/10 000 min of position of an AtoN ($\pm 180^\circ$, East = positive, West = negative 181 = (6791AC0 _h) = not available = default)
Latitude	27	Latitude in 1/10 000 min of an AtoN ($\pm 90^\circ$, North = positive, South = negative 91 = (3412140 _h) = not available = default)
Dimension/reference for position	30	Reference point for reported position; also indicates the dimension of an AtoN (m) (see Fig. 42 and § 4.1), if relevant ⁽¹⁾
Type of electronic position fixing device	4	0 = Undefined (default) 1 = GPS 2 = GLONASS 3 = Combined GPS/GLONASS 4 = Loran-C 5 = Chayka 6 = Integrated Navigation System 7 = surveyed. For fixed AtoN and virtual AtoN, the charted position should be used. The accurate position enhances its function as a radar reference target 8 = Galileo 9-14 = not used 15 = internal GNSS

TABLE 70 (end)

Parameter	Number of bits	Description
Time stamp	6	UTC second when the report was generated by the EPFS (0-59 or 60) if time stamp is not available, which should also be the default value or 61 if positioning system is in manual input mode or 62 if electronic position fixing system operates in estimated (dead reckoning) mode or 63 if the positioning system is inoperative)
Off-position indicator	1	For floating AtoN, only: 0 = on position; 1 = off position. NOTE 1 – This flag should only be considered valid by receiving station, if the AtoN is a floating aid, and if time stamp is equal to or below 59. For floating AtoN the guard zone parameters should be set on installation
AtoN status	8	Reserved for the indication of the AtoN status 00000000 = default
RAIM-flag	1	RAIM (Receiver autonomous integrity monitoring) flag of electronic position fixing device; 0 = RAIM not in use = default; 1 = RAIM in use see Table 47
Virtual AtoN flag	1	0 = default = real AtoN at indicated position; 1 = virtual AtoN, does not physically exist ⁽²⁾ .
Assigned mode flag	1	0 = Station operating in autonomous and continuous mode = default 1 = Station operating in assigned mode
Spare	1	Spare. Not used. Should be set to zero. Reserved for future use
Name of Aid-to-Navigation Extension	0, 6, 12, 18, 24, 30, 36, ... 84	This parameter of up to 14 additional 6-bit-ASCII characters for a 2-slot message may be combined with the parameter “Name of Aid-to-Navigation” at the end of that parameter, when more than 20 characters are needed for the name of the AtoN. This parameter should be omitted when no more than 20 characters for the name of the A-to-N are needed in total. Only the required number of characters should be transmitted, i.e. no @-character should be used
Spare	0, 2, 4, or 6	Spare. Used only when parameter “Name of Aid-to-Navigation Extension” is used. Should be set to zero. The number of spare bits should be adjusted in order to observe byte boundaries
Number of bits	272-360	Occupies two slots

⁽¹⁾ When using Fig. 41 for AtoN the following should be observed:

- For fixed Aids-to-Navigation, virtual AtoN, and for off-shore structures, the orientation established by the dimension A should point to true north.
- For floating aids larger than 2 m * 2 m the dimensions of the AtoN should always be given approximated to a circle, i.e. the dimensions should always be as follows A = B = C = D ≠ 0. (This is due to the fact that the orientation of the floating Aid to Navigation is not transmitted. The reference point for reported position is in the centre of the circle.)
- A = B = C = D = 1 should indicate objects (fixed or floating) smaller than or equal to 2 m * 2 m. (The reference point for reported position is in the centre of the circle.)

Notes relating to Table 70 (cont.):

- Floating off shore structures that are not fixed, such as rigs, should be considered as Code 31 type from Table 71 AtoN. These structures should have their “Dimension/reference for position” parameter as determined above in Note ⁽¹⁾.

For fixed off shore structures, Code 3 type from Table 71, should have their “Dimension/reference for position” parameter as determined above in Note ⁽¹⁾. Hence, all off shore AtoN and structures have the dimension determined in the same manner and the actual dimensions are contained in Message 21.

- ⁽²⁾ When transmitting virtual AtoN information, i.e. the virtual/pseudo AtoN Target Flag is set to one (1), the dimensions should be set to A=B=C=D=0 (default). This should also be the case, when transmitting “reference point” information (see Table 70).

This message should be transmitted immediately after any parameter value was changed.

Note on AtoN within AIS:

The competent international body for aids-to-navigation, IALA, defines an AtoN as: “a device or system external to vessels designed and operated to enhance safe and efficient navigation of vessels and/or vessel traffic.” (IALA Navguide, Edition 1997, Chapter 7).

The IALA Navguide stipulates: “A floating aid to navigation, which is out of position, adrift or during the night is unlighted, may itself become a danger to navigation. When a floating aid is out of position or malfunctioning, navigational warnings must be given.” Therefore, a station, which transmits Message 21, could also transmit safety related broadcast message (Message 14) upon detecting that the floating AtoN has gone out of position or is malfunctioning, at the competent authority’s discretion.

TABLE 71

The nature and type of AtoN can be indicated with 32 different codes

	Code	Definition
	0	Default, Type of AtoN not specified
	1	Reference point
	2	RACON
	3	Fixed structures off-shore, such as oil platforms, wind farms. (NOTE 1 – This code should identify an obstruction that is fitted with an AtoN AIS station)
	4	Spare, Reserved for future use
Fixed AtoN	5	Light, without sectors
	6	Light, with sectors
	7	Leading Light Front
	8	Leading Light Rear
	9	Beacon, Cardinal N
	10	Beacon, Cardinal E
	11	Beacon, Cardinal S
	12	Beacon, Cardinal W

TABLE 71 (*end*)

	Code	Definition
	14	Beacon, Starboard hand
	13	Beacon, Port hand
	14	Beacon, Starboard hand
	15	Beacon, Preferred Channel port hand
	16	Beacon, Preferred Channel starboard hand
	17	Beacon, Isolated danger
	18	Beacon, Safe water
	19	Beacon, Special mark
Floating AtoN	20	Cardinal Mark N
	21	Cardinal Mark E
	22	Cardinal Mark S
	23	Cardinal Mark W
	24	Port hand Mark
	25	Starboard hand Mark
	26	Preferred Channel Port hand
	27	Preferred Channel Starboard hand
	28	Isolated danger
	29	Safe Water
	30	Special Mark
	31	Light Vessel/LANBY/Rigs

NOTE 1 – The types of aids to navigation listed above are based on the IALA Maritime Buoyage System, where applicable.

NOTE 2 – There is potential for confusion when deciding whether an aid is lighted or unlighted. Competent authorities may wish to use the regional/local section of the message to indicate this.

3.20 Message 22: Channel management

This message should be transmitted by a base station (as a broadcast message) to command the VHF data link parameters for the geographical area designated in this message. The geographical area designated by this message should be as defined in § 4.1, Annex 2. Alternatively, this message may be used by a base station (as an addressed message) to command individual AIS mobile stations to adopt the specified VHF data link parameters. When interrogated and no channel management performed by the interrogated base station, the not available and/or international default settings should be transmitted (see § 4.1, Annex 2).

TABLE 72

Parameter	Number of bits	Description
Message ID	6	Identifier for Message 22; always 22
Repeat indicator	2	Used by the repeater to indicate how many times a message has been repeated. See § 4.6.1, Annex 2; 0-3; 0 = default; 3 = do not repeat any more
Station ID	30	MMSI number of Base station
Spare	2	Not used. Should be set to zero. Reserved for future use
Channel A	12	Channel number according to Recommendation ITU-R M.1084, Annex 4
Channel B	12	Channel number according to Recommendation ITU-R M.1084, Annex 4
Tx/Rx mode	4	0 = Tx A/Tx B, Rx A/Rx B (default) 1 = Tx A, Rx A/Rx B 2 = Tx B, Rx A/Rx B 3-15: not used When the dual channel transmission is suspended by Tx/Rx mode command 1 or 2, the required reporting interval should be maintained using the remaining transmission channel
Power	1	0 = high (default), 1 = low
Longitude 1, (or 18 most significant bits (MSBs) of addressed station ID 1)	18	Longitude of area to which the assignment applies; upper right corner (North-East); in 1/10 min, or 18 MSBs of addressed station ID 1 ($\pm 180^\circ$, East = positive, West = negative) 181 = not available
Latitude 1, (or 12 least significant bits (LSBs) of addressed station ID 1)	17	Latitude of area to which the assignment applies; upper right corner (North-East); in 1/10 min, or 12 LSBs of addressed station ID 1, followed by 5 zero bits ($\pm 90^\circ$, North = positive, South = negative) 91° = not available
Longitude 2, (or 18 MSBs of addressed station ID 2)	18	Longitude of area to which the assignment applies; lower left corner (South-West); in 1/10 min, or 18 MSBs of addressed station ID 2 ($\pm 180^\circ$, East = positive, West = negative)
Latitude 2, (or 12 LSBs of addressed station ID 2)	17	Latitude of area to which the assignment applies; lower left corner (South-West); in 1/10 min, or 12 LSBs of addressed station ID 2, followed by 5 zero bits ($\pm 90^\circ$, North = positive, South = negative)
Addressed or broadcast message indicator	1	0 = broadcast geographical area message = default; 1 = addressed message (to individual station(s))
Channel A bandwidth	1	0 = default (as specified by channel number); 1 = spare (formerly 12.5 kHz bandwidth in Recommendation ITU-R M.1371-1)

TABLE 72 (*end*)

Parameter	Number of bits	Description
Channel B bandwidth	1	0 = default (as specified by channel number); 1 = spare (formerly 12.5 kHz bandwidth in Recommendation ITU-R M.1371-1)
Transitional zone size	3	The transitional zone size in nautical miles should be calculated by adding 1 to this parameter value. The default parameter value should be 4, which translates to 5 nautical miles; see § 4.1.5, Annex 2
Spare	23	Not used. Should be set to zero. Reserved for future use
Number of bits	168	

3.21 Message 23: Group Assignment Command

The Group Assignment Command is transmitted by a Base station when operating as a controlling entity (see § 4.3.3.3.2 Annex 7 and § 3.20). This message should be applied to a mobile station within the defined region and as selected by “Ship and Cargo Type” or “Station type”. The receiving station should consider all selector fields concurrently. It controls the following operating parameters of a mobile station:

- transmit/ receive mode;
- reporting interval;
- the duration of a quiet time.

TABLE 73

Parameter	Number of bits	Description
Message ID	6	Identifier for Message 23; always 23
Repeat indicator	2	Used by the repeater to indicate how many times a message has been repeated. 0-3; default = 0; 3 = do not repeat any more
Source ID	30	MMSI of assigning station
Spare	2	Spare. Should be set to zero
Longitude 1	18	Longitude of area to which the group assignment applies; upper right corner (north-east); in 1/10 min ($\pm 180^\circ$, East = positive, West = negative)
Latitude 1	17	Latitude of area to which the group assignment applies; upper right corner (north-east); in 1/10 min ($\pm 90^\circ$, North = positive, South = negative)
Longitude 2	18	Longitude of area to which the group assignment applies; lower left corner (south-west); in 1/10 min ($\pm 180^\circ$, East = positive, West = negative)
Latitude 2	17	Latitude of area to which the group assignment applies; lower left corner (south-west); in 1/10 min ($\pm 90^\circ$, North = positive, South = negative)

TABLE 73 (*end*)

Parameter	Number of bits	Description
Station type	4	0 = all types of mobiles (default); 1 = Class A mobile stations only; 2 = all types of Class B mobile stations; 3 = SAR airborne mobile station; 4 = Class B "SO" mobile stations only; 5 = Class B "CS" shipborne mobile station only; 6 = inland waterways; 7 to 9 = regional use and; 10 to 15 = for future use
Type of ship and cargo type	8	0 = all types (default) 1...99 see Table 50 100...199 reserved for regional use 200...255 reserved for future use
Spare	22	Not used. Should be set to zero. Reserved for future use
Tx/Rx mode	2	This parameter commands the respective stations to one of the following modes: 0 = TxA/TxB, RxA/RxB (default); 1 = TxA, RxA/RxB, 2 = TxB, RxA/RxB, 3 = reserved for future use
Reporting interval	4	This parameter commands the respective stations to the reporting interval given in Table 74
Quiet time	4	0 = default = no quiet time commanded; 1-15 = quiet time of 1 to 15 min
Spare	6	Not used. Should be set to zero. Reserved for future use
Number of bits	160	Occupies one-time period

TABLE 74

Reporting interval settings for use with Message 23

Reporting interval field setting	Reporting interval for Message 23
0	As given by the autonomous mode
1	10 min
2	6 min
3	3 min
4	1 min
5	30 s
6	15 s
7	10 s
8	5 s
9	Next shorter reporting interval
10	Next longer reporting interval
11	2 s (not applicable to the Class B "CS")
12-15	Reserved for future use

NOTE 1 – When the dual channel transmission is suspended by Tx/Rx mode command 1 or 2, the required reporting interval should be maintained using the remaining transmission channel.

3.22 Message 24: Static data report

Message 24 Part A and Part B may be used by any AIS station to associate a MMSI with a name.

Message 24 Part A and Part B should be used by Class B “CS” shipborne mobile equipment. The message consists of two parts. Message 24B should be transmitted within 1 min following Message 24A.

In case of an interrogation for a Class B “CS” on a Message 24, the response should include Part A and Part B.

TABLE 75
Message 24 Part A

Parameter	Number of bits	Description
Message ID	6	Identifier for Message 24; always 24
Repeat indicator	2	Used by the repeater to indicate how many times a message has been repeated. 0 = default; 3 = do not repeat any more
User ID	30	MMSI number
Part number	2	Identifier for the message part number; always 0 for Part A
Name	120	Name of the MMSI-registered vessel. Maximum 20 characters 6-bit ASCII, @@@@ = not available = default. For SAR aircraft, it should be set to “SAR AIRCRAFT NNNNNNN” where NNNNNNN equals the aircraft registration number
Number of bits	160	Occupies one-time period

TABLE 76
Message 24 Part B

Parameter	Number of bits	Description
Message ID	6	Identifier for Message 24; always 24
Repeat indicator	2	Used by the repeater to indicate how many times a message has been repeated. 0 = default; 3 = do not repeat any more
User ID	30	MMSI number
Part number	2	Identifier for the message part number; always 1 for Part B
Type of ship and cargo type	8	0 = not available or no ship = default 1-99 = as defined in § 3.3.2 100-199 = reserved, for regional use 200-255 = reserved, for future use Not applicable to SAR aircraft
Vendor ID	42	Unique identification of the Unit by a number as defined by the manufacturer (option; “@@@@@” = not available = default) See Table 76A
Call sign	42	Call sign of the MMSI-registered vessel. 7 X 6 bit ASCII characters, “@@@@@” = not available = default

TABLE 76 (*end*)

Parameter	Number of bits	Description
Dimension of ship/reference for position. Or, for unregistered daughter vessels, use the MMSI of the mother ship	30	Dimensions of ship in metres and reference point for reported position (see Fig. 41 and § 3.3.3). Or, for an unregistered daughter vessel, use the MMSI of the associated mother ship in this data field. For SAR aircraft, the use of this field may be decided by the responsible administration. If used it should indicate the maximum dimensions of the craft. As default should A = B = C = D be set to "0"
Spare	6	
Number of bits	168	Occupies one-time period

TABLE 76A

Vendor ID field

Bit	Information	Description
(MSB) 41 24 (18 bits)	Manufacturer's ID	The Manufacturer's ID bits indicate the manufacture's mnemonic code consisting of three 6 bit ASCII characters ⁽¹⁾
23 20 (4 bits)	Unit Model Code	The Unit Model Code bits indicate the binary coded series number of the model. The first model of the manufacture uses "1" and the number is incremented at the release of a new model. The code reverts to "1" after reaching to "15". The "0" is not used
19 0 (LSB) (20 bits)	Unit Serial Number	The Unit Serial Number bits indicate the manufacture traceable serial number. When the serial number is composed of numeric only, the binary coding should be used. If it includes figure(s), the manufacture can define the coding method. The coding method should be mentioned in the manual

⁽¹⁾ IALA is presently considering the creation of an open international register of manufacturers' IDs.

3.23 Message 25: Single slot binary message

This message is primarily intended short infrequent data transmissions. The single slot binary message can contain up to 128 data-bits depending on the coding method used for the contents, and the destination indication of broadcast or addressed. The length should not exceed one slot. See application identifiers in § 2.1, Annex 5.

This message will not be acknowledged by either Message 7 or 13.

TABLE 77

Parameter	Number of bits	Description		
Message ID	6	Identifier for Message 25; always 25		
Repeat indicator	2	Used by the repeater to indicate how many times a message has been repeated. Refer to § 4.6.1, Annex 2; 0-3; default = 0; 3 = do not repeat any more		
Source ID	30	MMSI number of source station		
Destination indicator	1	0 = Broadcast (no Destination ID field used) 1 = Addressed (Destination ID uses 30 data bits for MMSI)		
Binary data flag	1	0 = unstructured binary data (no Application Identifier bits used) 1 = binary data coded as defined by using the 16-bit Application identifier		
Destination ID	0 / 30	If Destination indicator = 0 (Broadcast); no data bits are needed for the Destination ID If Destination indicator = 1; 30 bits are used for the MMSI number of the destination		
Binary data	Broadcast Maximum 128	Application identifier (if used)	16 bits	Should be as described in § 2.1, Annex 5
	Addressed Maximum 98	Application binary data	Broadcast Maximum 112 bits Addressed Maximum 82 bits	Application specific data
Maximum number of bits	Maximum 168	Occupies up to 1 slot subject to the length of sub-field message content		

TABLE 78

Gives the maximum number of binary data-bits for settings of destination indicator and coding method flags, such that, the message does not exceed one slot

Destination indicator	Coding method	Binary data (maximum bits)
0	0	128
0	1	112
1	0	98
1	1	82

3.24 Message 26: Multiple slot binary message with communications state

This message is primarily intended for scheduled binary data transmissions by applying either the SOTDMA or ITDMA access scheme. This multiple slot binary message can contain up to 1 004 data-bits (using 5 slots) depending on the coding method used for the contents, and the destination indication of broadcast or addressed. See application identifiers in § 2.1, Annex 5.

This message will not be acknowledged by either Message 7 or 13.

TABLE 79

Parameter	Number of bits	Description		
Message ID	6	Identifier for Message 26; always 26		
Repeat indicator	2	Used by the repeater to indicate how many times a message has been repeated. Refer to § 4.6.1, Annex 2; 0-3; default = 0; 3 = do not repeat any more		
Source ID	30	MMSI number of source station		
Destination indicator	1	0 = Broadcast (no Destination ID field used) 1 = Addressed (Destination ID uses 30 data bits for MMSI)		
Binary data flag	1	0 = unstructured binary data (no Application Identifier bits used) 1 = binary data coded as defined by using the 16-bit Application identifier		
Destination ID	0/30	If Destination indicator = 0 (Broadcast); no data bits are needed for the Destination ID If Destination indicator = 1; 30 bits are used for the MMSI number of the destination		
Binary data	Broadcast Maximum 108	Application identifier (if used)	16 bits	Should be as described in § 2.1, Annex 5
	Addressed Maximum 78	Application binary data	Broadcast Maximum 92 bits Addressed Maximum 62 bits	Application specific data
Binary data added by 2nd slot	224	Allows for 32 bits of bit-stuffing		
Binary data added by 3rd slot	224	Allows for 32 bits of bit-stuffing		
Binary data added by 4th slot	224	Allows for 32 bits of bit-stuffing		
Binary data added by 5th slot	224	Allows for 32 bits of bit-stuffing		
Communication state selector flag	1	0 = SOTDMA communication state follows 1 = ITDMA communication state follows		
Communication state	19	SOTDMA communication state (see § 3.3.7.2.1, Annex 2), if communication state selector flag is set to 0, or ITDMA communication state (§ 3.3.7.3.2, Annex 2), if communication state selector flag is set to 1		
Maximum number of bits	Maximum 1 064	Occupies 1 to 5 slots subject to the length of sub-field message content		

Table 80 gives the maximum number of binary data-bits for settings of destination indicator and coding method flags, such that, the message does not exceed the indicated number of slots.

TABLE 80

Destination indicator	Binary data flag	Binary data (maximum bits)				
		1-slot	2-slot	3-slot	4-slot	5-slot
0	0	108	332	556	780	1004
0	1	92	316	540	764	988
1	0	78	302	526	750	974
1	1	62	286	510	734	958

3.25 Message 27: Long-range AIS broadcast message

This message is primarily intended for long-range detection of AIS Class A equipped vessels (typically by satellite). This message has a similar content to Messages 1, 2 and 3, but the total number of bits has been compressed to allow for increased propagation delays associated with long-range detection. Refer to Annex 4 for details on Long-Range applications.

TABLE 81

Parameter	Number of bits	Description
Message ID	6	Identifier for this message; always 27
Repeat indicator	2	Always 3
User ID	30	MMSI number
Position accuracy	1	As defined for Message 1
RAIM flag	1	As defined for Message 1
Navigational status	4	As defined for Message 1
Longitude	18	Longitude in 1/10 min ($\pm 180^\circ$, East = positive, West = negative)
Latitude	17	Latitude in 1/10 min ($\pm 90^\circ$, North = positive, South = negative)
SOG	6	Knots (0-62); 63 = not available = default
COG	9	Degrees (0-359); 511 = not available = default
Status of current GNSS position	1	0 = Position is the current GNSS position; 1 = Reported position is not the current GNSS position = default
Spare	1	Set to zero, to preserve byte boundaries
Total number of bits	96	

NOTE 1 – There is no time stamp in this message. The receiving system is expected to provide the time stamp when this message is received.

Annex 9

Requirements for stations using burst transmissions

1 Requirements for stations using burst transmissions

This annex specifies how data should be formatted and transmitted for units that have limited range and operate in a low volume VDL. Burst transmission behaviour will increase the probability of reception and is required for units such as an AIS SART.

Burst behaviour conforms with Annex 2 with the minor modifications in the following sections:

- Transceiver characteristics.
- Transmitter transient response.
- Synchronization accuracy.
- Channel access scheme.
- User ID (Unique identifier).

2 Transceiver characteristics

TABLE 82

Required parameter settings

Symbol	Parameter name	Setting
PH.AIS1	Channel 1 (default channel 1)	161.975 MHz
PH.AIS2	Channel 2 (default channel 2)	162.025 MHz
PH.BR	Bit rate	9 600 bps
PH.TS	Training sequence	24 bits
PH.TST	Transmitter settling time (transmit power within 20% of final value. Frequency stable to within ± 1 kHz of final value). Tested at manufacturers declared transmit power	≤ 1.0 ms
	Ramp down time	≤ 832 μ s
	Transmission duration	≤ 26.6 ms
	Transmitter output power	Nominal 1W EIRP

In addition, the constants of the physical layer AIS station should comply with the values given in Tables 83 and 84.

TABLE 83

Required settings of physical layer constants

Symbol	Parameter name	Value
PH.DE	Data encoding	NRZI
PH.FEC	Forward error correction	Not used
PH.IL	Interleaving	Not used
PH.BS	Bit scrambling	Not used
PH.MOD	Modulation	Bandwidth adapted GMSK

TABLE 84

Modulation parameters of the physical layer

Symbol	Name	Value
PH.TXBT	Transmit BT-product	0.4
PH.MI	Modulation index	0.5

3 Transmitter requirements

The technical characteristics as specified in Table 85 should apply to the transmitter.

TABLE 85

Minimum required transmitter characteristics

Transmitter parameters	Requirements
Carrier power	Nominal radiated power 1 W
Carrier frequency error	± 500 Hz (normal). +1 000 Hz (extreme)
Slotted modulation mask	-20 dBc $\Delta f_c > \pm 10$ kHz -40 dBc ± 25 kHz $< \Delta f_c < \pm 62.5$ kHz See Annex 9
Transmitter test sequence and modulation accuracy	< 3 400 Hz for Bit 0, 1 (normal and extreme) 2 400 Hz \pm 480 Hz for Bit 2, 3 (normal and extreme) 2 400 Hz \pm 240 Hz for Bit 4 ... 31 (normal, 2 400 + 480 Hz extreme) For Bits 32 ... 199 1 740 \pm 175 Hz (normal, 1 740 + 350 Hz extreme) for a bit pattern of 0101 2 400 Hz \pm 240 Hz (normal, 2 400 + 350 Hz extreme) for a bit pattern of 00001111
Transmitter output power versus time	Power within mask shown in Annex 2 Fig. 2 and timings given in Annex 2 Table 6
Spurious emissions	Maximum 25 μ W 108 MHz to 137 MHz, 156 MHz to 161.5 MHz, and 1 525 MHz to 1 610 MHz

For information the emission mask specified above is shown in Fig. 42.

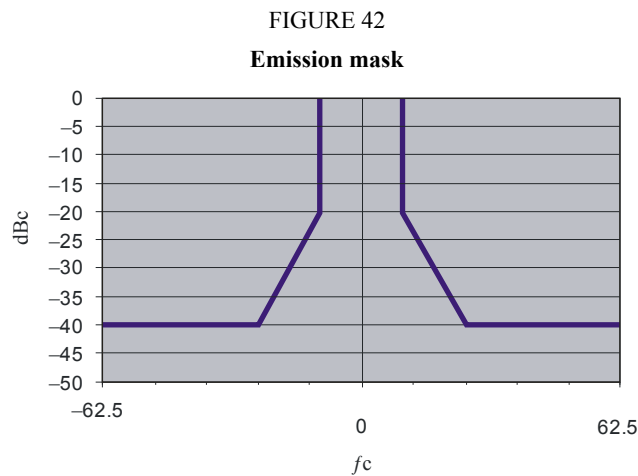

4 Synchronization accuracy

During UTC direct synchronization, the transmission timing error, including jitter, of the AIS station should be ± 3 bits ($\pm 312 \mu\text{s}$).

5 Channel access scheme

The AIS station should operate autonomously and determine its own schedule for transmission of its messages based on random selection of the first slot of the first burst. The other 7 slots within the first burst should be fixed referenced to the first slot of the burst. The increment between transmissions slots within a burst should be 75 slots and the transmissions should alternate between AIS1 and AIS2. The AIS station transmits messages in a burst of 8 messages no more than once per minute.

In active mode the AIS station should use messages with a communication state in the first burst. The communication state should set a slot-time-out = 7 in the first burst, thereafter the slot-time-out should be decreased according to the rules of SOTDMA. All slots should be regarded as candidates in the selection process. When time out occurs, the offset to the next set of 8 bursts is randomly selected between $1 \text{ min} \pm 6 \text{ s}$.

After the first burst any messages can be used in subsequent transmissions but should be on the slots reserved by the first burst.

In test mode, messages with a communication state should set slot-time-out = 0 and sub-message = 0 in the first and only burst.

The slot-time-out values of all messages' communication state within every burst should be the same.

Messages should be transmitted alternately on AIS 1 and AIS 2.

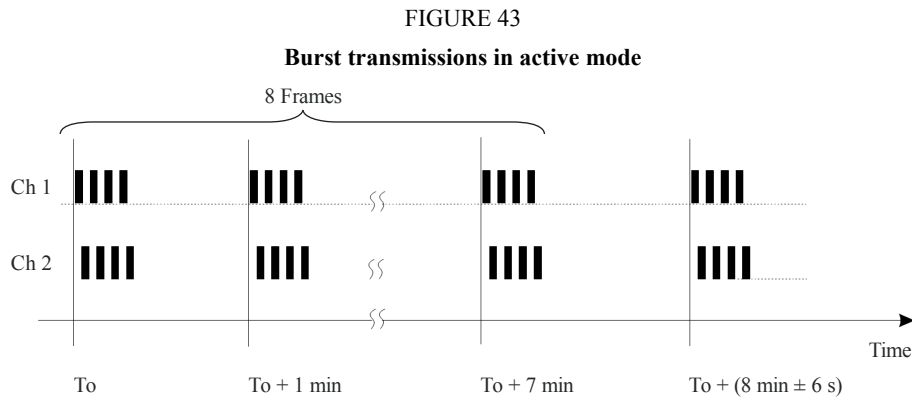

1371-43

6 User ID (Unique identifier)

The user ID should have a unique pattern such as the AIS-SART where the user ID is 970xxyyyy (where xx = manufacturer ID 01 to 99; xx = 00 is reserved for test purposes; yyyy = the sequence number 0000 to 9999).

Annex 10

Abbreviations in use in this Recommendation

ACK	Acknowledge
AIS	Automatic identification system
AIS-SART	AIS Search and Rescue Transmitter
ASCII	American standard code for information interchange
AtoN	Aid to navigation
BR	Bit rate
BS	Bit scrambling
BT	Bandwidth – Time
CHB	Channel bandwidth
CHS	Channel spacing
CIRM	International Maritime Radio Association (<i>Comité International Radio Maritime</i>)
COG	Course over ground
CP	Candidate period
CRC	Cyclic redundancy check
CS	Carrier sense
CSTDMA	Carrier sense time division multiple access

DAC	Designated area code
DE	Data encoding
DG	Dangerous goods
DGNSS	Differential global navigation satellite system
DLS	Data link service
DSC	Digital selective calling
DTE	Data terminal equipment
ECDIS	Electronic chart display and information system
ENC	Electronic navigation chart
EPFS	Electronic position fixing system
ETA	Estimated time of arrival
FATDMA	Fixed access time-division multiple access
FCS	Frame check sequence
FEC	Forward error correction
FI	Function identifier
FIFO	First-in, first-out
FM	Frequency modulation
FTBS	FATDMA block size
FTI	FATDMA increment
FTST	FATDMA start slot
GLONASS	Global navigation satellite system
GMDSS	Global maritime distress and safety system
GMSK	Gaussian filtered minimum shift keying
GNSS	Global navigation satellite system
GPS	Global positioning system
HDG	Heading
HDLC	High level data link control
HS	Harmful substances
HSC	High speed craft
IAI	International application identifier
IALA	International Association of Marine Aids to Navigation and Lighthouse Authorities
ICAO	International Civil Aviation Organization
ID	Identifier
IEC	International Electrotechnical Commission
IFM	International function message
IL	Interleaving

IMO	International Maritime Organization
ISO	International Standardization Organization
ITDMA	Incremental time division multiple access
ITINC	ITDMA slot increment
ITKP	ITDMA keep flag
ITSL	ITDMA number of slots
ITU	International Telecommunication Union
kHz	Kilohertz
LME	Link management entity
LSB	Least significant bit
MAC	Medium access control
MAX	Maximum
MHz	Megahertz
MID	Maritime identification digits
MIN	Minimum
MMSI	Maritime mobile service identity
MOD	Modulation
MP	Marine pollutants
MSB	Most significant bit
NI	Nominal increment
NM	Nautical mile
NRZI	Non return zero inverted
NS	Nominal slot
NSS	Nominal start slot
NTS	Nominal transmission slot
NTT	Nominal transmission time
OSI	Open system interconnection
PI	Presentation Interface
ppm	Parts per million
RAI	Regional application identifier
RAIM	Receiver autonomous integrity monitoring
RATDMA	Random access time-division multiple access
RF	Radio frequency
RFM	Regional function message
RFR	Regional frequencies
RI	Reporting interval(s)

ROT	Rate of turn
RR	Radio Regulations
Rr	Reporting rate (position reports per minute)
RTA	RATDMA attempts
RTCSC	RATDMA candidate slot counter
RTES	RATDMA end slot
RTP1	RATDMA calculated probability for transmission
RTP2	RATDMA current probability for transmission
RTPI	RATDMA probability increment
RTPRI	RATDMA priority
RTPS	RATDMA start probability
Rx	Receiver
RXBT	Receive BT-product
SAR	Search and rescue
SI	Selection interval
SO	Self organized
SOG	Speed over ground
SOTDMA	Self organized time division multiple access
TDMA	Time division multiple access
TI	Transmission interval
TMO	Time-out
TS	Training sequence
TST	Transmitter settling time
Tx	Transmitter
TXBT	Transmit BT-product
TXP	Transmitter output power
UTC	Coordinated universal time
VDL	VHF data link
VHF	Very high frequency
VTS	Vessel traffic services
WGS	World geodetic system
WIG	Wing in ground
